

15

PVC-KUGELHÄHNE, FITTINGE, ROHRE, KLEBER UND KLEBESCHLÄUCHE

- 1 GEGENSCHWIMM-, MASSAGE- UND LUFTSPRUDELANLAGEN
- 2 PORTABLE WHIRLPOOLS UND EINBAUTEILE
- 3 EINBAUTEILE AUS ROTGUSS UND EDELSTAHL V4A
- 4 EINBAUTEILE AUS KUNSTSTOFF
- 5 FILTERPUMPEN
- 6 FILTERANLAGEN AUS KUNSTSTOFF UND POLYESTER
- 7 FILTER-SOLAR- UND RÜCKSPÜLSTEUERUNGEN
- 8 SAUNA, DAMPFBAD UND ZUBEHÖR
- 9 WÄRMETAUSCHER, ENTFEUCHTUNGSGERÄTE, WÄRMEPUMPEN UND SOLARANLAGEN
- 10 EDELSTAHLLEITERN UND BRAUSEN, SOLARDUSCHEN
- 11 REINIGUNGSGERÄTE, RINNENSTEINE UND AUSKLEIDFOLIEN
- 12 MESS-, REGEL- UND DOSIERTECHNIK
- 13 SCHWIMMBADABDECKSYSTEME MANUELL UND AUTOMATISCH
- 14 SCHWIMMBADPFLEGEMITTEL
- 15 PVC-KUGELHÄHNE, FITTINGE, ROHRE, KLEBER UND KLEBESCHLÄUCHE**



SCHWIMMBADKUGELHÄHNE PVC / TYP EURO CEPEX



Klebeanschluss

Dichtung KLEBE/CR, O-Ring EPDM Temperaturbeständig bis 60°

D	Art.-Nr.	DN	PN	L	H	E	VE
20	436501	15	16	16	87	50	24
25	436502	20	16	19	101	61	14
32	436503	25	16	22	122	70	8
40	436504	32	16	26	135	81	6
50	436505	40	16	31	149	96	10
63	436506	50	16	38	174	118	10
75*)	436507	65	16	44	216	146	4
90*)	436508	80	16	51	256	176	1
110*)	436509	100	16	63	359	228	1

beidseitig gesichert! Industrierausführung auf Anfrage!

SCHWIMMBADKUGELHÄHNE PVC / TYP STANDARD CEPEX



Klebeanschluss

Dichtung HDPE/CR, O-Ring EPDM Temperaturbeständig bis 60°

D	Art.-Nr.	DN	PN	L	H	E	VE
16	04099	15	16	16	84	52	12
20	04100	15	16	16	84	52	12
25	04101	20	16	19	108	62	6
32	04102	25	16	22	124	70	8
40	04103	32	16	26	142	84	6
50	04104	40	16	31	167	104	6
63	04105	50	16	38	198	120	9
75*)	04106	65	10	44	232	148	1
90*)	04107	80	10	51	269	179	1
110*)	04108	80	10	61	275	179	1

SCHWIMMBADKUGELHÄHNE PVC / CEPEX



Klebeanschluss

Dichtung HDPE/CR, O-Ring EPDM Temperaturbeständig bis 60°

D	Art.-Nr.	DN	PN	L	H	E	VE
50	04134	40	10	31	162	94	10
63	04135	50	10	38	192	117	10
50	441544	40	12	31	149	96	10
63	441545	50	12	38	174	118	10

beidseitig gesichert!



Klebenippel und Tülle

Dichtung HDPE/CR, O-Ring EPDM Temperaturbeständig bis 90°

Art.-Nr.	DN	VE	DA	H
04136	32	16	40 x Tülle	162
04137	40 x 40	16	Tülle x Tülle	192



ERSATZTEILE SCHWIMMBADKUGELHÄHNE PN 16 / 12 TYP EURO CEPEX



PN16/12

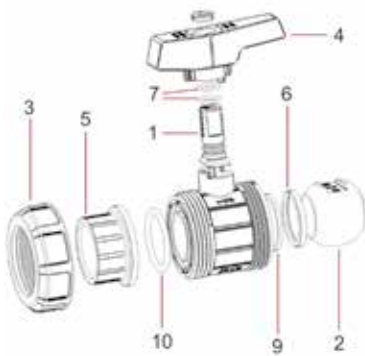

PN12

Bezeichnung	DA	TL	Ref.-Nr.	Art.-Nr.
Üw.-Mutter für	16/20	3	(36501R0104)	4365011
Üw.-Mutter für	25	3	(36502R0104)	4365021
Üw.-Mutter für	32	3	(36503R0104)	4365031
Üw.-Mutter für	40	3	(36504R0104)	4365041
Üw.-Mutter für	50	3	(36505R0104)	4365051
Üw.-Mutter für	63	3	(36506R0104)	4365061
Üw.-Mutter für	75	3	(36507R0104)	4365071
Üw.-Mutter für	90	3	(36508R0104)	4365081
Üw.-Mutter für	110	3	(36509R0104)	4365091
Einlegeteil Klebe	16	5	(36500R0105)	4365002
Einlegeteil Klebe	20	5	(36501R0105)	4365012
Einlegeteil Klebe	25	5	(36502R0105)	4365022
Einlegeteil Klebe	32	5	(36503R0105)	4365032
Einlegeteil Klebe	40	5	(36504R0105)	4365042
Einlegeteil Klebe	50	5	(36505R0105)	4365052
Einlegeteil Klebe	63	5	(36506R0105)	4365062
Einlegeteil Klebe	75	5	(36507R0105)	4365072
Einlegeteil Klebe	90	5	(36508R0105)	4365082
Einlegeteil Klebe	110	5	(36509R0105)	4365092
O-Ring Einlegeteil	16/20	10	(723R0202035)	041003
O-Ring Einlegeteil	25	10	(723R0282035)	041013
O-Ring Einlegeteil	32	10	(723R0329035)	041023
O-Ring Einlegeteil	40	10	(723R0407053)	041033
O-Ring Einlegeteil	50	10	(723R0470053)	041043
O-Ring Einlegeteil	63	10	(723R0597053)	041053
O-Ring Einlegeteil	75	10	(723R0756053)	041063
O-Ring Einlegeteil	90	10	(723R0914053)	041073
O-Ring Einlegeteil	110	10	(723R1092057)	041083
O-Ring Set	16/20	6-10	(36501R0135)	4365006
O-Ring Set	25	6-10	(36502R0135)	4365016
O-Ring Set	32	6-10	(36503R0135)	4365036
O-Ring Set	40	6-10	(36504R0135)	4365046
O-Ring Set	50	6-10	(36505R0135)	4415446
O-Ring Set	63	6-10	(36506R0135)	4415447
O-Ring Set	75	6-10	(36507R0135)	4365076
O-Ring Set	90	6-10	(36508R0135)	4365086
O-Ring Set	110	6-10	(36509R0135)	4365096
Zapfen + O-Ringe	16/20	1+7	(36501R0121)	4365015
Zapfen + O-Ringe	25	1+7	(36502R0121)	4365025
Zapfen + O-Ringe	32	1+7	(36503R0121)	4365035
Zapfen + O-Ringe	40	1+7	(36504R0121)	4365045
Zapfen + O-Ringe	50	1+7	(36505R0121)	4365055
Zapfen + O-Ringe	63	1+7	(36506R0121)	4365065
Zapfen + O-Ringe	75	1+7	(36507R0121)	4365075
Zapfen + O-Ringe	90	1+7	(36508R0121)	4365085
Zapfen + O-Ringe	110	1+7	(22797R0121)	4365095

ERSATZTEILE SCHWIMMBADKUGELHÄHNE PN 12 TYP EURO CEPEX

Bezeichnung	DA	TL	Ref.-Nr.	Art.-Nr.
Üw.-Mutter für	50	3	(41941R0104)	4415441
Üw.-Mutter für	63	3	(41545R0104)	4415451
Einlegeteil Klebe	50	5	(36515R0105)	4415442
Einlegeteil Klebe	63	5	(36516R0105)	4415452
O-Ring Einlegeteil	50	9	(723R0470053)	041043
O-Ring Einlegeteil	63	9	(723R0597053)	041053
O-Ring Set	50	6-10	(36505R0135)	4415446
O-Ring Set	63	6-10	(36506R0135)	4415447

ERSATZTEILE SCHWIMMBADKUGELHÄHNE PN 16 / 10 TYP STANDARD CEPEX

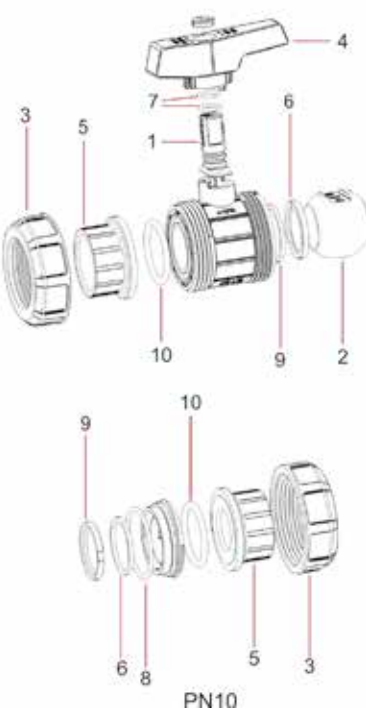
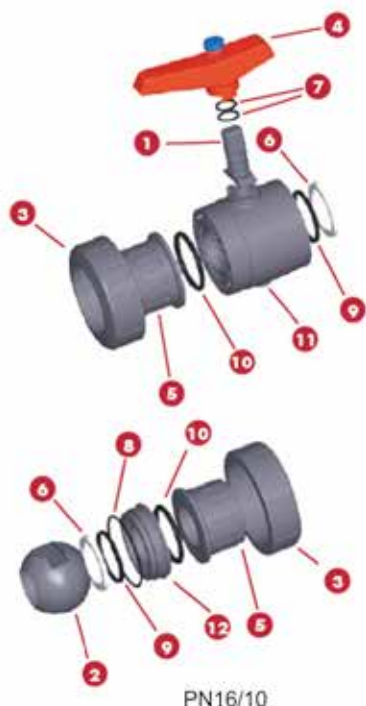

Bezeichnung	DA	TL	Ref.-Nr.	Art.-Nr.
Üw.-Mutter für	16/20	3	(02453R0104)	041001
Üw.-Mutter für	25	3	(02454R0104)	041011
Üw.-Mutter für	32	3	(02455R0104)	041021
Üw.-Mutter für	40	3	(02456R0104)	041031
Üw.-Mutter für	50	3	(02457R0104)	041041
Üw.-Mutter für	63	3	(02458R0104)	041051
Üw.-Mutter für	75	3	(02459R0104)	041061
Üw.-Mutter für	90	3	(02460R0104)	041071
Üw.-Mutter für	110	3	(22797R0104)	041081
Einlegeteil Klebe	16	5	(05352R0105)	040992
Einlegeteil Klebe	20	5	(02453R0105)	041002
Einlegeteil Klebe	25	5	(02454R0105)	041012
Einlegeteil Klebe	32	5	(02455R0105)	041022
Einlegeteil Klebe	40	5	(02456R0105)	041032
Einlegeteil Klebe	50	5	(02457R0105)	041342
Einlegeteil Klebe	63	5	(02458R0105)	041052
Einlegeteil Klebe	75	5	(02459R0105)	041062
Einlegeteil Klebe	90	5	(02460R0105)	041072
Einlegeteil Klebe	110	5	(22797R0105)	041082
O-Ring Einlegeteil	16/20	10	(723R0202035)	041003
O-Ring Einlegeteil	25	10	(723R0282035)	041013
O-Ring Einlegeteil	32	10	(723R0329035)	041023
O-Ring Einlegeteil	40	10	(723R0407053)	041033
O-Ring Einlegeteil	50	10	(723R0470053)	041043
O-Ring Einlegeteil	63	10	(723R0597053)	041053
O-Ring Einlegeteil	75	10	(723R0756053)	041063
O-Ring Einlegeteil	90	10	(723R0914053)	041073
O-Ring Einlegeteil	110	10	(723R1092057)	041083
O-Ring Set	16/20	7-10	(02453R0129)	041008
O-Ring Set	25	7-10	(02454R0129)	041018
O-Ring Set	32	7-10	(02455R0129)	041028
O-Ring Set	40	7-10	(02456R0129)	041038
O-Ring Set	50	7-10	(02457R0129)	041048
O-Ring Set	63	7-10	(02458R0129)	041058
O-Ring Set	75	7-10	(02459R0129)	041068
O-Ring Set	90	7-10	(02460R0129)	041078
O-Ring Set	110	7-10	(22797R0129)	041088
Zapfen + O-Ringe	16/20	1+7	(02453R0121)	041000
Zapfen + O-Ringe	25	1+7	(02454R0121)	041010
Zapfen + O-Ringe	32	1+7	(02455R0121)	041020
Zapfen + O-Ringe	40	1+7	(02456R0121)	041030
Zapfen + O-Ringe	50	1+7	(02457R0121)	041040
Zapfen + O-Ringe	63	1+7	(02458R0121)	041050
Zapfen + O-Ringe	75	1+7	(02459R0121)	041060
Zapfen + O-Ringe	90	1+7	(02460R0121)	041070
Zapfen + O-Ringe	110	1+7	(22797R0121)	4365095

ERSATZTEILE SCHWIMMBADKUGELHÄHNE PN10 TYP STANDARD CEPEX

Bezeichnung	DA	TL	Ref.-Nr.	Art.-Nr.
Üw.-Mutter für	50	3	(02502R0104)	041341
Üw.-Mutter für	63	3	(02503R0104)	041351
Einlegeteil Klebe	50	5	(02457R0105)	041342
Einlegeteil Klebe	63	5	(02503R0105)	041352
O-Ring Einlegeteil	50	10	(723R0470053)	041043
O-Ring Einlegeteil	63	10	(723R0597053)	041053
O-Ring Set 4-teilig	50	7-10	(02502R0129)	041046
O-Ring Set 4-teilig	63	7-10	(02458R0129)	041058

3-WEGE-SCHWIMMBADKUGELHÄHNE PVC-PN 16 / 10 CEPEX



Klebeanschluss, Dichtung HDPE, O-Ring EPDM,
Temperaturbeständig bis 60° Typ PN10

DN	VE	Art.-Nr.	DA
40	1	04139	50
40	1	04138	50/63

PVC-Sichtgläser – CEPEX



DN	VE	Art.-Nr.	DA
40	1	04165	50
50	1	04166	63
63	1	04167	75
75	1	04168	90
90	1	04169	110
110	1	04170	140
140	1	04171	160
200	1	041711	225

PVC-ABLASSVENTILE



Material: PVC max. Betriebsdruck: PN 10

Beschreibung	Art.-Nr.	Gewinde
Ablassventil schwarz	080671	3/4" AG x 3/4" AG
Ablassventil schwarz	080681	3/4" AG x NW 16 (Gardenaanschluss)
Ablassventil	04116	3/4" IG / 3/4" AG
Üw-Mutter und Tülle	04118	3/4" IG x NW 19
Ablassventil	04468	1/4" AG x NW 10

PVC-ZUGSCHIEBER – VALTERRA

PVC-Zugschieber versehen mit einer Spindel aus Edelstahl mit 3-facher Dichtung im oberen Teil (3 x O-Ring). Anwendungen: Teiche, Schwimmbäder, Whirlpools, Tanks, Gartenbau. Die Zugschieber sind mit Sanlopren Abdichtungen (100 % chemisch beständig) versehen, die sowohl für Vakuum als auch für Druck geeignet sind. Der Schieber ist aus Kunststoff, außer der 110/160/200 mm, dieser ist aus Edelstahl. Ideal für Niederdruck-Anlagen. Auf Anfrage auch in inch-Klebeverbindungen lieferbar.



Typ	A	B	C	D	E	F
50mm	188	222	72.6	50.3	98	98
63mm	191	260	85.4	63.3	111	105
75/90mm	238	324	111	75.3	130	133
90mm	238	324	111	90.3	130	133
110mm	330	454	169	110.4	181	130
160mm	572	800	279.4	160.7	343	279
200mm	572	797	279.4	200.7	327	276

Ø = Höhe bei komplett geöffneter Schraube

2 x Klebemuffe

Arbeitsdruck bei 20°C	VE	Art.-Nr.	DA
max. 3,5 bar	28	SBSBI20	50
max. 2,8 bar	16	SBSBI21	63
max. 1,4 bar	12	SBSBI19	75
max. 1,4 bar	12	SBSBI22	90
max. 1,4 bar	12	SBSBI18	90 (mit Edstahlschieber)
max. 1,0 bar	6	SBSBI23	110 (mit Edstahlschieber)
max. 1,0 bar	1	SBSBI24	160 (mit Edstahlschieber)
max. 1,0 bar	1	SBSBI25	200 (mit Edstahlschieber)

PVC-ABSPERRSCHIEBER ASTRAL CEPEX



Art.-Nr.	Bezeichnung
428940	Absperrschieber Außengewinde 6/4" / Tülle NW 38, VE = 10 (28940) grau
428941	Absperrschieber Klebemuffe DA 50 / Tülle NW 38, VE = 10 (28935) grau
428942	Absperrschieber Klebemuffe / Klebemuffe DA 50, VE = 10 (28590) grau
428943	Absperrschieber Innengewinde 6/4" / Außengewinde 6/4", VE = 10 (28942) grau
428944	Absperrschieber Innengewinde 6/4" / Tülle NW 38, VE = 10 (28947) grau

RÜCKSCHLAGVENTILE KLEBE CEPEX



**Material: PVC 16 bar Dichtung
PVC-Klebeanschluss EPDM Standardausführung Federbelastet**

D	Art.-Nr.	DN	PN	H	L	E	VE
20	04151	15	16	84	16	52	48
25	04152	20	16	108	19	62	24
32	04153	25	16	119	22	70	20
40	04154	32	16	142	26	84	12
50	04155	40	16	162	31	94	24
63	04156	50	16	192	38	117	12
75	04157	65	16	232	44	148	4
90	04158	80	16	269	51	179	2
110	04159	100	16	279	61	229	2

PVC-SCHRÄGSITZ RÜCKSCHLAGVENTILE

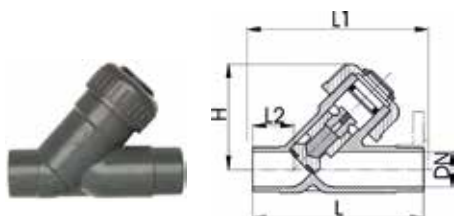

Material: PVC-U, ABS 10 bar Dichtung
PVC-Klebeanschluss EPDM/FPM

D	Art.-Nr.	DN	PN	H	L	L ₁	L ₂
20	16227	15	10	65	124	130	28
25	162271	20	10	75	144	150	37
32	162272	25	10	90	154	160	37
40	162273	32	10	102	174	180	44
50	162274	40	10	123	194	200	48
63	162275	50	10	144	224	230	60

PVC-RÜCKSCHLAGVENTIL RÜCKSCHLAGVENTIL TRANSPARENT MIT KLEBEANSCHLUSS



D	Art.-Nr.	
50	476782	Rückschlagventil Klebeanschluss ohne Feder
63	476783	Rückschlagventil Klebeanschluss ohne Feder
50	476740	Rückschlagventil Klebeanschluss mit Feder
63	476741	Rückschlagventil Klebeanschluss mit Feder



D50 - 0,7 m³/h
D63 - 0,8 m³/h
minimaler Durchfluss
um die Feder zu öffnen

	D50	D63
D	50	63
E	80	95
H	198	231
L	28	35
A	140	156
J	126	143

PVC-RÜCKSCHLAGKLAPPEN – CEPEX – nicht federbelastet mit Flanschanschluss im Set

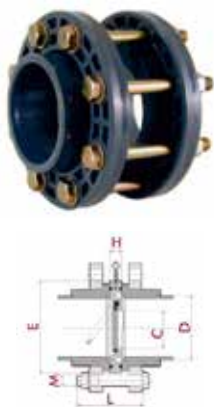

D	Art.-Nr.	DN	PN	C	H	E	VE
63	437073	50	10	32	20	109	2
75	423312	65	10	40	20	129	2
90	423313	80	10	52	20	144	3
110	423314	100	10	70	23	164	2
125	423315	110	10	83	25	170	2
140	423316	125	10	92	24	195	2
160	423317	150	6	112	26	220	1
200	423318	175	6	139	28	247	1
225	423319	200	6	150	35	275	1
250	437074	250	6	162	40	328	1
315	437075	300	6	226	45	380	1

PVC-RÜCKSCHLAGKLAPPEN – CEPEX – federbelastet



D	Art.-Nr.	PN	A	B	C	VE
63	437055	10	109	20	32	15
75	408984	10	129	20	40	10
90	408985	10	144	20	52	8
110	408986	10	164	23	70	5
140	408987	10	195	24	92	10
160	408988	6	220	26	112	5
225	408989	6	275	35	150	3

PP-GF-ABSPERRKLAPPEN CEPEX INDUSTRIEAUSFÜHRUNG



PP-GF Gehäuse
 Blauer Farbpunkt
 O-Ringe EPDM nahrungsmittelverträglich
 Achse Edelstahl (AISI630)
 PVC-U Scheiben
 Handhebel in PP
 Auf Anfrage mit Viton-Dichtung

VE	Art.-Nr.	DA	PN
2	432620	63-75	10
2	432621	90	10
2	432622	110	10
2	432623	125-140	10
2	432624	160	10
1	432625	200-225	10

D	DN	A	B	C	E	F	G	H	K	L	M	N	E	S	holes
63-75	65	201	156	120	40	18	112	48	125-145	220	70	9	35	10	4
90	80	232	190	136	40	19	112	52	150-170	245	70	9	35	12	8
110	100	255	212	148	40	19	112	59	180-192	245	70	9	35	16	8
125-140	125	284	238	164	40	22	112	66	190-215	320	70	9	35	20	8
160	150	314	256	180	40	24	112	72	240	320	70	9	35	20	8
200-225	200	378	320	217	30	23	136	73	270-298	391	102	11	47	26	8

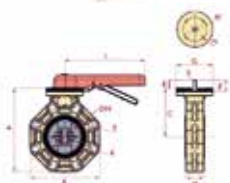

PP-GF Gehäuse
 O-Ringe EPDM nahrungsmittelverträglich
 Achse Edelstahl (AISI630)
 PVC-U Scheiben
 Auf Anfrage mit Viton-Dichtung

VE	Art.-Nr.	DA	PN
1	434466	63-75	10
1	434467	90	10
1	434468	110	10
1	434469	125-140	10
1	434470	160	10
1	434471	200-225	10
1	434472	250-280	6
1	432738	315	6

D	DN	A	B	E	C	F	G	H	K	holes
63-75	65	190	156	160	245	18	218	48	125-145	4
90	80	221	190	160	276	19	249	52	150-170	8
110	100	244	212	160	299	19	272	59	150-192	8
125-140	125	273	238	160	328	22	301	66	190-215	8
160	150	303	265	160	358	24	301	72	240	8
200-225	200	366	320	310	421	23	394	73	270-298	8
250-280	250	450	453	310	525	29	488	114	355-362	12
315	300	545	477	310	616	29	578	114	390-432	12

PVC-ABSPERRKLAPPEN CEPEX STANDARDAUSFÜHRUNG



Handbetätigt / Normalausführung
 Material: EPDM
 ohne Flansch und Bundbuchse

DN	Art.-Nr.	DA	PN
65	04120	75	10
80	04121	90	10
100	04122	110	10
125	04123	140	10
150	04124	160	10
200	04125	225	10
225	415846	250	6

FLANSCHSETZ FÜR ABSPERRKLAPPE

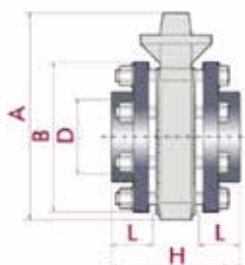

DN	Art.-Nr.	DA	PN
50	409119	63	10
65	409120	75	10
80	409121	90	10
100	409122	110	10
110	409123	125	10
125	409124	140	10
150	409125	160	10
175	409126	200	10
200	409127	225	10
225	416060	250	10

PP-MOTORKLAPPEN PNEUMATISCH CEPEX



Absperrklappe mit pneumatischem Stellantrieb, doppelt wirkend, Dichtung EPDM, Achse aus Edelstahl, komplett mit Magnetventil 230 V und Stellungsanzeige VE

VE	Art.-Nr.	DA	
1	402664	75	
1	402665	90	
1	402666	110	
1	402668	140	
1	402669	160	
1	402670	225	

430737 Umschalt-Ersatz-Magnetventil 230V
für alle pneumatischen Absperrklappen

PP-MOTORKLAPPEN ELEKTRISCH CEPEX



Absperrklappe mit elektrischem Stellantrieb 80 - 240 V Gleich- oder Wechselstrom Dichtung EPDM, Achse aus Edelstahl
Mit Sicherheitsblock – schliesst bei Stromausfall automatisch!

VE	Art.-Nr.	DA	
1	405382	75	
1	405383	90	
1	405384	110	
1	405386	140	
1	405387	160	
1	405388	225	

PVC-2/3-WEGE-MOTORKUGELHÄHNE 230 V CEPEX



Typ AS, 230 Volt, PVC-Klebeanschluss EPDM Teflondichtung

VE	Art.-Nr.	DN	DA	
40	04266	50	50	2-Wege
50	042660	63	63	2-Wege
40	427228	50	50	3-Wege mit Sicherheitsblock
40	405370	50	50	2-Wege mit Sicherheitsblock
50	405371	63	63	2-Wege mit Sicherheitsblock
40	042663	50	50	3-Wege

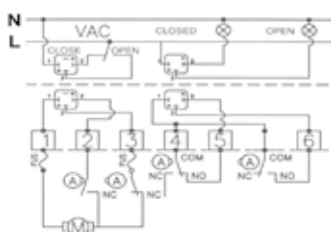

Ventildurchm.	Elektrisches Stellglied	Maß "D"
20	U-0	64
25	U-0	64
32	U-0	74
40	U-0	74
50	R-0	88
63	R-0	88
75	R-1	123
90	R-1	123

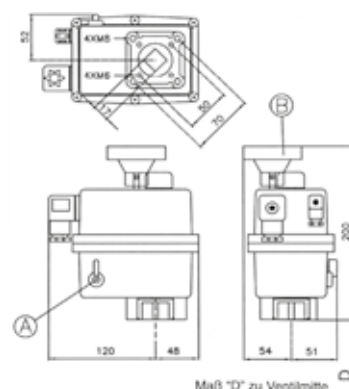

PVC-FITTINGE – CEPEX

Cepex-Experten in der Übertragung der Flüssigkeit - In mehr als 25-jähriger Marktpräsenz konnte Cepex stets höchste Kundenzufriedenheit erzielen und sich dank Ihrer Unterstützung und Treue als einer der europäischen Hauptlieferanten von Ventilen und Fittings aus Plastik etablieren. Dies führte zum Aufbau eines eigenen weltweiten Vertriebsnetzes. Unternehmensphilosophie - Cepex vereint alle Kräfte, um dem Markt effiziente Lösungen anzubieten und verfolgt dabei fünf Prinzipien mit dem Ziel, zuverlässige und konkurrenzfähige Produkte zu präsentieren: Forschung - Um sich vom derzeitigen Markt abzuheben, müssen die Unternehmen in der Lage sein, auf die sich schnell ändernden Nachfragen und Wünsche der Kunden zu reagieren. Deshalb setzt Cepex stetig auf Innovation und Forschung, unterstützt von einer Expertengruppe der I+D, die systematisch die verschiedenen Märkte analysieren, um Produkte und praktikable Lösungen für den Bedarf anzubieten. Technologie - Der Produktionsprozess, angefangen von der Konzeption des Produktes bis hin zur seiner Auslieferung an den Kunden, wird mit Hilfe der fortgeschrittensten Technologie und ständiger Weiterentwicklung derselben dazu genutzt, um ein Maximum an Qualität und ein Minimum an Fehlern zu garantieren. Dies erreicht Cepex Holding durch: Eigene Werkzeugfabrik, Spritzgussmaschinen, Robotern und Spitzentechnologien, einem hochentwickelten Logistikzentrum

Qualität - Die Produktionsprozesse werden von einem Qualitätsmanagement-System begleitet, sie sind durch die Zertifizierung ISO 9001 dokumentiert. Die Produkte sind härtesten Kontrollen unterworfen, was eine 100%-Überprüfung eines jeden Ventilmodells bedeutet. Cepex erhielt daher zahlreiche Auszeichnungen, die weltweit anerkannte Prüfinstitute verliehen. Service - Eine der wesentlichen Aufgaben der Mitarbeiter aller Tochtergesellschaften und alle zur Gruppe gehörenden Teams liegen in der optimalen Betreuung ihrer Kunden. Ihm gegenüber steht eine erfahrene Mannschaft von Technikern und Kaufleuten, die Fragen zum Produkt und dessen Funktionen zuverlässig beantworten können. Umweltpolitik - Cepex ist eine Firma, die verantwortlich mit der Umwelt umgeht. Damit alle eine saubere Umwelt genießen können, wird die Wahl der Produktionsmittel sorgfältig abgewogen. Um dieser Verpflichtung gerecht zu werden, ist in unseren Produktionsstätten ein auf der ISO 14001-Norm basierendes Regelwerk installiert, das alle erforderlichen Aktivitäten und Dienste vorschreibt.

Prüfzeichen und Zertifikate:



PVC-FITTINGE-PN10-CEPEX Farbedunkelgrau ca. RAL 7024



Winkel 90° Klebemuffe / Klebemuffe

D	Art.-Nr.	DN	PN	VE	
50	419206	40	10	70	CE
63	419207	50	10	36	CE

Winkel 45° Klebemuffe / Klebemuffe

50	419210	40	10	40	CE
63	419211	50	10	48	CE

T-Stück egal 3x Klebemuffe

50	419208	40	10	48	CE
63	419209	50	10	24	CE

Muffen

50	419212	40	10	60	CE
63	419213	50	10	35	CE

Übergangsnippel

50 x 1 1/2" AG	419214	40	10	48	CE
63 x 2" AG	419215	50	10	24	CE

Verschraubungen Klebemuffe / Klebemuffe

50	402331	40	10	30	CE
63	402332	50	10	12	CE

PVC-FITTINGE – CEPEX Farbe dunkelgrau ca. RAL 7024

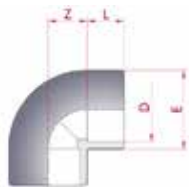

Winkel 90° Klebemuffe / Klebemuffe

D	Art.-Nr.	DN	PN	L	Z	E	VE	
16	411655	10	16	14	10	25	20	
20	401712	15	16	16	11	27	20	
25	401713	20	16	19	14	33	10	
32	401714	25	16	22	17	41	10	
40	401715	32	16	26	21	50	55	
50	401716	40	16	31	26	61	60	
63	401717	50	16	38	33	76	36	
75	401718	65	16	44	39	90	21	
90	401719	80	16	51	46	108	12	
110	401720	100	16	61	56	131	14	
125	401721	110	16	69	64	148	10	
140	401722	125	16	76	71	164	5	
160	401723	150	10	86	81	180	4	
200	401724	175	10	106	101	225	3	
225	401725	200	10	119	114	252	2	
250	401726	225	10	131	126	284	2	
315	401727	300	10	164	159	352	1	
400	434807	353	5	206	202	439	3	

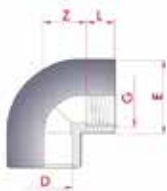

Übergangswinkelwinkel 90° Klebemuffe / IG

D x G	Art.-Nr.	DN	PN	L	Z	E	VE	
20 x 1/2"	401728	15	10	14	11	28	10	
25 x 3/4"	401729	20	10	16	14	34	10	
32 x 1"	401730	25	10	19	17	43	10	
40 x 1 1/4"	401731	32	10	20	21	54	10	
50 x 1 1/2"	401732	40	10	20	26	63	28	
63 x 2"	401733	50	10	24	33	78	16	
75 x 2 1/2"	422596	65	10	44	40	89	9	
90 x 3"	422597	80	10	51	48	106	6	
110 x 4"	422598	100	10	61	58	129	3	

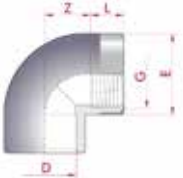

Übergangswinkelwinkel 90° verstärkt Klebemuffe / IG

D x G	Art.-Nr.	DN	PN	L	Z	E	VE	
20 x 1/2"	401740	15	16	14	11	28	10	
25 x 3/4"	401741	20	16	16	14	34	10	
32 x 1"	401742	25	16	19	17	43	10	
40 x 1 1/4"	401743	32	16	20	21	54	10	
50 x 1 1/2"	401744	40	16	20	26	63	28	
63 x 2"	401745	50	10	24	33	78	16	

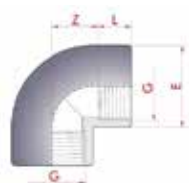

Winkel 90° IG / IG

D	Art.-Nr.	DN	PN	L	Z	E	VE	
1/2"	401734	15	10	14	11	28	10	
3/4"	401735	20	10	16	14	34	10	
1"	401736	25	10	19	17	43	10	
1 1/4"	401737	32	10	20	21	54	10	
1 1/2"	401738	40	10	20	26	63	28	
2"	401739	50	10	24	33	78	16	
2 1/2"	422587	65	10	30	54	89	9	
3"	422588	80	10	33	66	106	6	
4"	422589	100	10	39	80	129	3	

PVC-FITTINGE – CEPEX Farbe dunkelgrau ca. RAL 7024

Reduzierwinkel 90° Klebemuffe / Klebemuffe



D x D - d	Art.-Nr.	DN	PN	L	LI	E	VE	
50 x 50 - 40	402237	40	16	31	26	61	60	
63 x 63 - 50	402238	50	16	38	31	76	32	

Winkel 90° Klebemuffe /AG

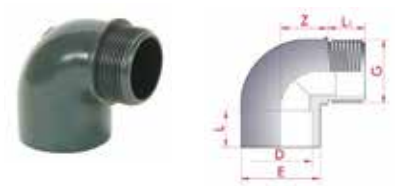

D x G	Art.-Nr.	DN	PN	LI	L	E	Z	VE	
50 x 1 1/2"	402239	40	10	21	31	61	38	80	
63 x 2"	402240	50	10	25	38	76	47	42	

Winkel 45° Klebemuffe / Klebemuffe

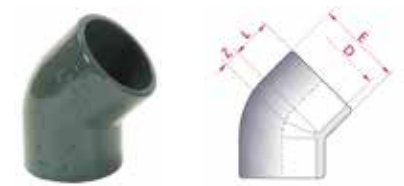

D	Art.-Nr.	DN	PN	L	Z	E	VE	
16	416307	10	16	14	5	22	20	
20	401746	15	16	16	5	28	20	
25	401747	20	16	19	6	35	10	
32	401748	25	16	22	8	43	10	
40	401749	32	16	26	10	52	60	
50	401750	40	16	31	12	61	80	
63	401751	50	16	38	14	76	45	
75	401752	65	16	44	17	93	25	
90	401753	80	16	51	20	109	15	
110	401754	100	16	61	24	133	16	
125	401755	110	16	69	27	148	12	
140	401756	125	16	76	30	164	8	
160	401757	150	10	86	34	180	5	
200	401758	175	10	106	43	225	4	
225	401759	200	10	119	48	252	2	
250	401760	225	10	131	53	284	2	
315	401761	300	10	164	67	352	1	
400	434808	353	5	206	83	439	4	

Übergangswinkelwinkel 45° verstärkt Klebemuffe / IG

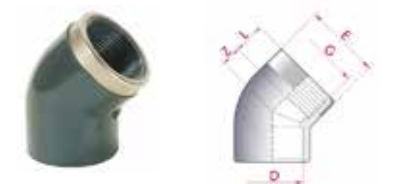

D x G	Art.-Nr.	DN	PN	L	Z	E	VE	
20 x 1 1/2"	401774	15	16	14	5	28	10	
25 x 3/4"	401775	20	16	16	6	34	10	
32 x 1"	401776	25	16	19	8	43	10	
40 x 1 1/4"	401777	32	16	20	10	54	10	
50 x 1 1/2"	401778	40	16	20	12	63	35	
63 x 2"	401779	50	16	24	14	78	18	



Reduzierwinkel 45° Klebemuffe / Klebemuffe

D x D - d	Art.-Nr.	DN	PN	L	LI	E	VE	
50 x 50 - 40	402241	32	16	31	26	61	90	
63 x 63 - 50	402242	40	16	38	31	76	50	

PVC-FITTINGE – CEPEX Farbe dunkelgrau ca. RAL 7024

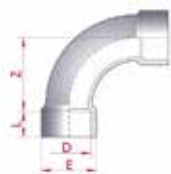

Bogen 90° Klebemuffe / Klebemuffe

D	Art.-Nr.	DN	PN	L	Z	E	VE	
20	401967	15	16	16	40	27	10	
25	401968	20	16	19	50	33	10	
32	401969	25	16	22	64	41	24	
40	401970	32	16	26	80	50	25	
50	401971	40	16	31	100	61	30	
63	401972	50	16	38	126	76	15	
75	401973	65	16	44	150	90	8	
90	405331	80	16	51	180	113	4	
110	405332	100	16	61	134	132	4	
125	405333	110	10	69	186	150	5	
140	405334	125	10	76	166	164	4	
160	405335	150	10	86	194	186	4	
200	405336	175	4	106	284	223	1	

Muffe egal Klebemuffe / Klebemuffe



D	Art.-Nr.	DN	PN	L	Z	E	VE	
16	416309	10	16	14	3	22	20	
20	401872	15	16	16	3	27	20	
25	401873	20	16	19	3	33	20	
32	401874	25	16	22	3	41	20	
40	401875	32	16	26	3	50	10	
50	401876	40	16	31	3	61	56	
63	401877	50	16	38	3	75	34	
75	401878	65	16	44	4	90	14	
90	401879	80	16	51	5	108	18	
110	401880	100	16	61	6	129	12	
125	401881	110	16	69	7	148	16	
140	401882	125	16	76	9	164	12	
160	401883	150	10	86	9	180	6	
200	401884	175	10	106	10	225	3	
225	401885	200	10	119	10	252	4	
250	401886	225	10	131	12	280	2	
315	401887	300	10	164	12	352	1	
400	405329	375	6	206	12	432	1	



PVC-FITTINGE – CEPEX Farbe dunkelgrau ca. RAL 7024



Verschraubung 3-teilig Klebemuffe / Klebemuffe, EPDM O-Ring

D	Art.-Nr.	DN	PN	L	LI	Z	G	E	O	VE
16	420157	12	16	14	14	13	3/4"	34	15,5 x 2,6	10
20	402327	15	16	16	16	13	1"	41	20,2 x 3,5	10
25	402328	20	16	19	19	13	1 1/4"	52	28,2 x 3,5	10
32	402329	25	16	22	22	13	1 1/2"	60	32,9 x 3,5	30
40	402330	32	16	26	26	15	2"	74	40,6 x 5,3	40
50	402331	40	16	31	31	17	2 1/4"	80	47,0 x 5,3	30
63	402332	50	16	38	38	21	2 3/4"	99	59,7 x 5,3	12
75	402333	65	10	44	44	21	3 1/2"	120	75,6 x 5,3	16
90	402334	80	10	51	51	24	4"	138	91,4 x 5,3	12
110	402335	100	10	61	61	26	5 1/2"	179	110,5 x 5,3	5

Übergangs-Verschraubung 3-teilig Klebemuffe / IG, EPDM O-Ring

D x G	Art.-Nr.	DN	PN	L	LI	Z	GI	E	O	VE
16 x 3/8"	420158	12	16	14	14	13	3/4"	34	15,5 x 2,6	10
20 x 1/2"	402336	15	16	16	16	13	1"	41	20,2 x 3,5	10
25 x 3/4"	402337	20	16	19	19	13	1 1/4"	52	28,2 x 3,5	10
32 x 1"	402338	25	16	22	22	13	1 1/2"	60	32,9 x 3,5	30
40 x 1 1/4"	402339	32	16	26	26	15	2"	74	40,6 x 5,3	40
50 x 1 1/2"	402340	40	16	31	31	17	2 1/4"	80	47,0 x 5,3	30
63 x 2"	402341	50	16	38	38	21	2 3/4"	99	59,7 x 5,3	12
75 x 2 1/2"	402342	65	10	44	44	21	3 1/2"	120	75,6 x 5,3	16
90 x 3"	402343	80	10	51	51	24	4"	138	91,4 x 5,3	12
110 x 4"	402344	100	10	61	61	26	5 1/2"	179	110,5 x 5,3	5



Verschraubung 3-teilig Klebemuffe / Klebestutzen, EPDM O-Ring

D	Art.-Nr.	DN	PN	L	LI	Z	VE
50	402351	40	16	31	31	48	20
63	402352	50	16	38	38	62	12



Übergangs-Verschraubung 3-teilig Klebemuffe / AG, EPDM O-Ring ohne O-Ring am Gewinde

D x G	Art.-Nr.	DN	PN	LI	L	Z	VE
16 x 3/8"	420160	12	16	14	12	29	10
20 x 1/2"	402353	15	16	16	15	33	10
25 x 3/4"	402354	20	16	19	16	35	10
32 x 1"	402355	25	16	22	19	40	30
40 x 1 1/4"	402356	32	16	26	21	40	36
50 x 1 1/2"	402357	40	16	31	21	48	30
63 x 2"	402358	50	16	38	28	62	12
75 x 2 1/2"	402359	65	10	44	30	70	16
90 x 3"	402360	80	10	51	33	62	10
110 x 4"	402361	100	10	61	40	70	4



Übergangs-Verschraubung 3-teilig Klebemuffe / AG, EPDM O-Ring mit O-Ring am Gewinde

D x G	Art.-Nr.	DN	PN	L	LI	Z	VE
50 x 1 1/2"	407716	40	16	31	21	49	30
50 x 2"	426638	40	16	31	28	46	12
63 x 2"	407717	50	16	38	28	51	12



Anschlussstück orientierbar max. Falschrichtung +/- 4° Klebemuffe / AG

D x G	Art.-Nr.	DN	PN	L	VE
50 x 1 1/2"	418874	40	10	110	6



PVC-FITTINGE – CEPEX Farbe dunkelgrau ca. RAL 7024

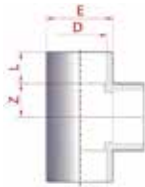

T-Stück 90° 3 x Klebemuffe

D	Art.-Nr.	DN	PN	L	Z	E	VE	
16	416308	10	16	14	9	22	20	
20	401780	15	16	16	11	27	20	
25	401781	20	16	19	14	33	10	
32	401782	25	16	22	17	41	10	
40	401783	32	16	26	21	50	40	
50	401784	40	16	31	26	63	48	
63	401785	50	16	38	33	78	24	
75	401786	65	16	44	39	90	15	
90	401787	80	16	51	46	108	8	
110	401788	100	16	61	56	131	10	
125	401789	110	16	69	64	148	7	
140	401790	125	16	76	71	164	4	
160	401791	150	10	86	81	186	3	
200	401792	175	10	106	101	228	2	
225	401793	200	10	119	114	255	2	
250	401794	225	10	131	126	284	1	
315	401795	300	10	164	159	356	1	
400	405328	325	4	206	280	432	3	

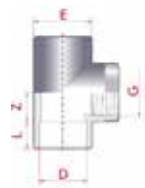

Übergangs T-Stück 90° verstärkt Klebemuffe / IG, Edelstahl

D x G	Art.-Nr.	DN	PN	L	Z	E	VE	
20 x 1/2"	401808	15	16	14	11	28	10	
25 x 3/4"	401809	20	16	16	14	34	10	
32 x 1"	401810	25	16	19	17	43	10	
50 x 1 1/2"	401812	40	16	20	26	63	21	

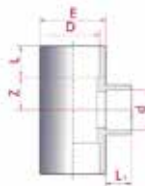

T-Stück reduziert 90° 3 x Klebemuffe

D x d	Art.-Nr.	DN	PN	L	LI	Z	E	VE	
25 x 20	401814	20 - 15	16	19	16	14	33	10	
32 x 25	401815	25 - 20	16	22	19	17	41	10	
32 x 20	401816	25 - 15	16	22	16	17	41	10	
40 x 32	401817	32 - 25	16	26	22	21	50	48	
40 x 25	401818	32 - 20	16	26	19	21	50	48	
50 x 40	401820	40 - 32	16	31	26	26	61	48	
50 x 32	401821	40 - 25	16	31	22	26	61	48	
50 x 25	401822	40 - 20	16	31	19	26	61	54	
50 x 20	401823	40 - 15	16	31	16	26	61	56	
63 x 50	401824	50 - 40	16	38	31	33	76	27	
63 x 40	401825	50 - 32	16	38	26	33	76	28	
63 x 32	401826	50 - 25	16	38	22	33	76	30	
63 x 25	401827	50 - 20	16	38	19	33	76	30	
63 x 20	401828	50 - 15	16	38	16	33	76	30	
75 x 63	401829	65 - 50	16	44	38	39	90	16	
75 x 50	401830	65 - 40	16	44	31	39	90	18	
75 x 40	401831	65 - 32	16	44	26	39	90	18	
75 x 32	401832	65 - 25	16	44	22	39	90	18	
90 x 75	401833	80 - 65	16	51	44	46	108	9	
90 x 63	401834	80 - 50	16	51	38	46	108	9	
90 x 50	401835	80 - 40	16	51	31	46	108	9	
90 x 40	401836	80 - 32	16	51	26	46	108	9	
110 x 90	401837	100 - 80	16	61	51	56	131	11	
110 x 75	401838	100 - 65	16	61	44	56	131	12	
110 x 63	401839	100 - 50	16	61	38	56	131	12	
110 x 50	401840	100 - 40	16	61	31	56	131	12	
125 x 110	401841	110 - 100	16	69	61	64	149	7	
125 x 90	401842	110 - 80	16	69	51	64	149	8	
125 x 75	401843	110 - 65	16	69	44	64	149	8	
125 x 63	401844	110 - 50	16	69	38	64	149	8	
140 x 125	401845	125 - 110	16	76	69	71	162	5	
140 x 110	401846	125 - 100	16	76	61	71	162	6	
140 x 90	401847	125 - 80	16	76	51	71	162	6	
140 x 75	401848	125 - 65	16	76	44	71	162	6	
160 x 140	407688	150 - 125	10	86	76	81	186	3	
160 x 125	407689	150 - 110	10	86	69	81	186	3	
160 x 110	407690	150 - 100	10	86	61	81	186	3	
160 x 90	407691	150 - 80	10	86	51	81	186	3	

PVC-FITTINGE – CEPEX Farbe dunkelgrau ca. RAL 7024

T-Stück 45° 3 x Klebemuffe



D x d	Art.-Nr.	DN	PN	L	Z	ZI	E	VE
20	422583	15	16	16	7	29	28	10
25	422584	20	16	19	7	36	34	10
32	422585	25	16	22	8	44	42	24
40	422586	32	16	26	10	54	51	30
50	420155	40	10	31	13	67	61	32
63	420156	50	10	38	15	83	76	18
75	432804	65	10	44	18	101	91	11
90	432805	80	10	51	20	122	106	6
110	432806	100	10	61	27	149	133	7

Kreuz-Stück 4 x Klebemuffe

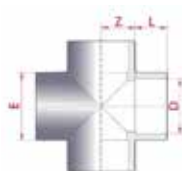

D	Art.-Nr.	DN	PN	L	Z	E	VE
20	420143	15	16	16	11	29	10
25	420144	20	16	19	14	35	10
32	420145	25	16	22	17	43	10
40	420146	32	16	26	21	52	30
50	402235	40	16	31	26	63	32
63	402236	50	16	38	33	79	16
75	427958	65	16	42	39	92	12
90	422581	80	16	51	46	106	12
110	422582	100	16	61	56	130	6

Übergangsmuffe Klebemuffe /IG

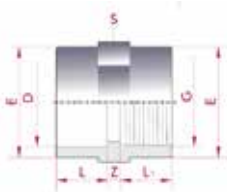

D x G	Art.-Nr.	DN	PN	L	LI	Z	E	S	VE
16 x 3/8"	401888	12	10	14	14	3	22	22	20
20 x 1/2"	401889	15	10	16	14	3	28	27	20
25 x 3/4"	401890	20	10	19	16	3	34	33	20
32 x 1"	401891	25	10	22	19	3	43	41	20
40 x 1 1/4"	401892	32	10	26	20	3	54	50	10
50 x 1 1/2"	401893	40	10	31	20	3	63	61	56
63 x 2"	401894	50	10	38	24	3	78	75	28
75 x 2 1/2"	401895	65	10	44	44	4	90	90	14
90 x 3"	401896	80	10	51	51	6	108	108	24
110 x 4"	401897	90	10	61	61	6	135	135	10

Übergangsmuffe, verstärkt Klebemuffe /IG, Edelstahl

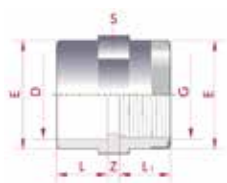

D x G	Art.-Nr.	DN	PN	L	LI	Z	E	S	VE
20 x 1/2"	401908	15	16	16	14	3	28	27	20
25 x 3/4"	401909	20	16	19	16	3	34	33	10
32 x 1"	401910	25	16	22	19	3	43	41	10
40 x 1 1/4"	401911	32	16	26	20	3	54	50	10
50 x 1 1/2"	401912	40	16	31	20	3	63	61	56
63 x 2"	401913	50	16	38	24	3	78	75	28

PVC-FITTINGE – CEPEX Farbe dunkelgrau ca. RAL 7024

Reduktion kurz Klebemuffe / Klebestutzen

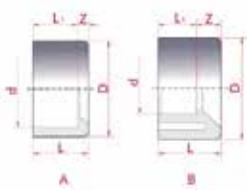

D x d	Art.-Nr.	DN	PN	L	LI	Z	Mod.	VE
20 x 16	401914	10	16	16	14	2	A	20
25 x 20	401915	15	16	19	16	3	A	20
32 x 25	401916	20	16	22	19	3	A	20
32 x 20	401917	15	16	22	16	6	A	20
40 x 32	401918	25	16	26	22	4	A	20
40 x 25	401919	20	16	26	19	7	A	10
40 x 20	401920	15	16	26	16	10	B	10
50 x 40	401921	32	16	31	26	5	A	20
50 x 32	401922	25	16	31	22	9	B	10
50 x 25	401923	20	16	31	19	12	B	10
50 x 20	401924	15	16	31	16	15	B	10
63 x 50	401925	40	16	38	31	7	A	48
63 x 40	401926	32	16	38	26	12	B	10
63 x 32	401927	25	16	38	22	16	B	10
75 x 63	401928	50	16	44	38	6	A	28
75 x 50	418685	40	16	44	31	13	B	28
75 x 40	418686	32	16	44	26	18	B	28
90 x 75	401929	65	16	51	44	7	A	36
90 x 63	418687	50	16	51	38	13	B	36
90 x 50	418688	40	16	51	31	20	B	36
110 x 90	401930	80	16	61	51	10	A	16
110 x 75	418689	65	16	61	44	17	B	16
110 x 63	418690	50	16	61	38	23	B	16
125 x 110	401931	100	16	69	61	8	A	24
125 x 90	418691	80	16	69	51	18	B	12
125 x 75	420142	65	16	69	44	25	B	12
140 x 125	401932	110	16	76	69	8	A	20
140 x 110	418692	100	16	76	61	15	B	10
160 x 140	401933	125	10	86	76	10	A	12
160 x 110	418693	100	10	86	61	25	B	6
200 x 180	401934	160	10	106	96	10	A	6
200 x 160	401935	150	10	106	86	20	B	6
225 x 200	401936	175	10	119	106	13	A	7
225 x 160	401937	150	10	119	86	33	B	7
250 x 225	401938	200	10	131	119	12	A	6
250 x 200	401939	175	10	131	106	25	B	6
315 x 280	410093	-	6	-	-	-	-	3
315 x 250	401940	225	6	164	131	33	B	3
315 x 225	401941	200	6	164	119	45	B	3
400 x 315	405330	300	6	206	163	42	B	1



Einlegeteile

DA x l/2° x L	Art.-Nr.	DN	VE
50 x 1/2° x 34	40599155	40	10
63 x 1/2° x 41	40599167	50	10
50 x 3/4° x 34	40599156	40	10
63 x 3/4° x 41	40599166	50	10

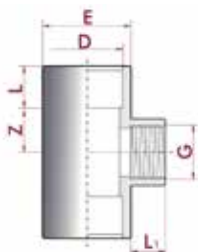

T-Stück reduziert 90° 2x Klebemuffe, Gewinde

D x d	Art.-Nr.	DN	PN	L	LI	Z	E	VE
50 x 1/2°	401883	40 - 15	10	31	14	26	61	24
63 x 1/2°	401863	50 - 15	10	38	14	33	76	15
50 x 3/4°	401857	40 - 20	10	31	16	26	61	24
63 x 3/4°	401862	50 - 20	10	38	16	33	76	15

PVC-FITTINGE – CEPEX Farbe dunkelgrau ca. RAL 7024

Reduktion lang Klebemuffe / Klebestutzen



D - Ex d	Art.-Nr.	DN	PN	L	LI	Z	F	VE
32-25 x 25	401974	20	16	22	19	30	33	10
32-25 x 20	401975	15	16	22	16	30	27	10
40-32 x 32	401976	25	16	26	22	36	38	10
40-32 x 25	401977	20	16	26	19	36	33	10
40-32 x 20	401978	15	16	26	16	36	27	10
50-40 x 40	401979	32	16	31	26	44	48	10
50-40 x 32	401980	25	16	31	22	44	41	10
50-40 x 25	401981	20	16	31	19	44	33	10
50-40 x 20	401982	15	16	31	16	44	27	10
63-50 x 50	401983	40	16	38	31	54	61	20
63-50 x 40	401984	32	16	38	26	54	50	46
63-50 x 32	401985	25	16	38	22	54	41	30
63-50 x 25	401986	20	16	38	19	54	33	30
63-50 x 20	401987	15	16	38	16	54	27	30
75-63 x 63	401988	50	16	44	38	62	73	26
75-63 x 50	401989	40	16	44	31	62	61	40
75-63 x 40	401990	32	16	44	26	62	50	40
75-63 x 32	401991	25	16	51	44	74	87	40
90-75 x 75	401992	-	16	-	-	-	-	12
90-75 x 63	401993	50	16	51	38	74	75	34
90-75 x 50	401994	40	16	51	31	74	61	48
90-75 x 40	401995	32	16	51	26	74	50	24
110-90 x 90	401996	80	16	61	51	88	105	16
110-90 x 75	401997	65	16	61	44	88	90	18
110-90 x 63	401998	50	16	61	38	88	75	27
110-90 x 50	401999	40	16	61	31	88	61	27
125-110 x 90	402000	80	16	69	51	100	105	18
125-110 x 75	402001	65	16	69	44	100	90	18
125-110 x 63	402002	50	16	69	38	100	75	20
140-125 x 110	402003	100	16	76	61	111	130	9
140-125 x 90	402004	80	16	76	51	111	105	12
140-125 x 75	402005	65	16	76	44	111	90	12
160-140 x 125	402006	110	10	86	69	126	148	11
160-140 x 110	402007	100	10	86	61	126	130	14
160-140 x 90	402008	80	10	86	51	126	105	18
200-180 x 140	402009	125	10	106	76	154	157	6
200-180 x 125	402010	110	10	106	69	154	148	6
200-180 x 110	402011	100	10	106	61	154	130	6
225-200 x 160	402012	150	10	119	86	171	180	3
225-200 x 140	402013	125	10	119	76	171	160	3
225-200 x 125	402014	110	10	119	69	171	148	4
250-225 x 200	402015	175	10	131	106	194	225	2
250-225 x 160	402016	150	10	131	86	194	180	2
250-225 x 140	402017	125	10	131	76	194	157	3
315-280 x 200	402018	175	6	164	106	233	225	2
315-280 x 160	402019	150	6	164	86	233	180	2

Reduktion lang exzentrisch Klebemuffe / Klebestutzen



D - Ex d	Art.-Nr.	DN	PN	L	LI	Z	VE
90 - 75 x 63	409030	50	16	51	38	74	12

PVC-FITTINGE – CEPEX Farbe dunkelgrau ca. RAL 7024

Bundbuchse glatt PVC-U Klebemuffe

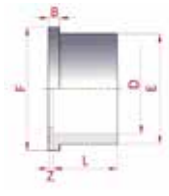

D	Art.-Nr.	DN	PN	L	Z	B	E	F	VE
20	407692	15	16	16	3	6	27	34	20
25	407693	20	16	19	3	7	33	41	20
32	407694	25	16	22	3	7	41	50	20
40	407695	32	16	26	3	8	50	61	10
50	402020	40	16	31	3	8	61	73	40
63	402021	50	16	38	3	9	76	90	18
75	402022	65	16	44	3	10	90	106	29
90	402023	80	16	51	5	11	108	125	14
110	402024	100	16	61	5	12	131	150	20
125	402025	110	16	69	5	13	148	168	14
140	402026	125	16	76	5	14	165	188	10
160	402027	150	10	86	5	16	188	213	12
200	402028	175	10	106	6	20	225	247	7
225	402029	200	10	119	6	25	248	274	6
250	402030	225	10	131	8	27	282	328	5
315	402031	300	10	164	8	30	342	378	3
400	405341	375	6	206	12	30	432	483	2
500	405342	480	4	153	8	24	532	574	1

Losflansch PVC-U

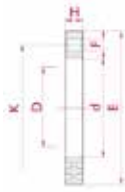

D	Art.-Nr.	DN	PN	d	E	H	K	F	VE
20	407696	15	16	28	95	12	65	14 x 4	10
25	407697	20	16	34	105	13	75	14 x 4	10
32	407698	25	16	42	115	15	85	14 x 4	10
40	407699	32	16	51	140	16	100	18 x 4	22
50	402032	40	16	62	150	17	110	18 x 4	18
63	402033	50	16	78	165	18	125	18 x 4	20
75	402034	65	16	92	185	22	145	18 x 4	15
90	402035	80	16	110	200	23	160	18 x 8	34
110	402036	100	16	133	220	24	180	18 x 8	22
125	402037	110	16	150	230	26	190	18 x 8	18
140	402038	125	16	167	250	28	210	18 x 8	16
140 x 125	402039	110	16	149	250	28	210	18 x 8	16
160	402040	150	10	190	285	31	240	22 x 8	12
200	402041	175	10	227	315	32	270	22 x 8	8
225	402042	200	10	250	340	32	295	22 x 8	5
225 x 200	409039	175	10	227	342	32	295	22 x 8	5
250	402043	225	10	285	399	34	350	22 x 12	6
315	402044	300	10	345	450	36	400	22 x 12	6
400	405343	375	6	438	572	34	515	25 x 16	2
500	405344	480	4	533	657	30	600	25 x 20	2

Blindflansch PVC-U

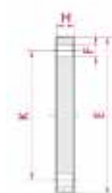

D	Art.-Nr.	DN	PN	H	E	K	F	VE
20	422561	15	16	11	95	65	14 x 4	10
25	422562	20	16	12	105	75	14 x 4	10
32	422563	25	16	14	115	85	14 x 4	10
40	422564	32	16	15	142	100	18 x 4	20
50	422565	40	16	16	152	110	18 x 4	16
63	422566	50	16	18	165	125	18 x 4	10
75	422567	65	16	19	185	145	18 x 4	7
90	422568	80	16	20	200	160	18 x 8	10
110	422569	100	16	22	220	180	18 x 8	6
125	422570	110	16	24	230	190	18 x 8	5
140	422571	125	16	26	250	210	18 x 8	5
160	422572	150	10	28	285	240	22 x 8	5
200	422573	175	10	30	340	295	22 x 8	5
225	422574	200	10	30	340	295	22 x 8	4

PVC-FITTINGE – CEPEX Farbe dunkelgrau ca. RAL 7024

Flachdichtung aus EVA (D400 / D500: EPDM)



D	Art.-Nr.	DN	d	E	H	K	F	VE
20	407700	15	20	32	2	65	14	20
25	407701	20	25	39	2	75	14	20
32	407702	25	32	48	2	85	14	20
40	407703	32	40	59	2	100	18	20
50	402061	40	50	71	3	110	18	20
63	402062	50	63	88	3	125	18	20
75	402063	65	75	104	3	145	18	10
90	402064	80	90	123	3	160	18	20
110	402065	100	110	148	4	180	18	20
125	402066	110	125	166	4	190	18	10
140	402067	125	140	186	4	210	18	10
160	402068	150	160	211	4	240	22	40
200	402069	175	200	245	5	270	22	30
225	402070	200	225	275	5	295	22	30
250	402071	225	250	328	3	350	22	10
315	402072	300	315	378	3	400	22	6
400	405345	353	438	572	3	-	-	6
500	405346	475	533	657	3	-	-	6

Flanschsatz Klebemuffe



D	Art.-Nr.	DN	PN	L	VE
75	402371	65	10	97	3
90	402372	80	10	115	2
110	402373	100	10	136	3
125	402374	110	10	152	3
140	402375	125	10	166	2
160	402376	150	6	186	2
200	402377	175	6	227	1
225	402378	200	6	255	1

Schrauben, Muttern und U-Scheiben Stahl 5.6 verzinkt



M	Art.-Nr.	A/DIN931	B/DIN934	C/DIN25	VE
M 12 x 60	416061	M 12 x 60	M 12	Ø12	4
M 16 x 70	402437	M 16 x 70	M 16	Ø16	8
M 16 x 80	402438	M 16 x 80	M 16	Ø16	8
M 16 x 90	402439	M 16 x 90	M 16	Ø16	8
M 16 x 120	402440	M 16 x 120	M 16	Ø16	4
M 16 x 130	402441	M 16 x 130	M 16	Ø16	8
M 16 x 140	402442	M 16 x 140	M 16	Ø16	4
M 16 x 150	402443	M 16 x 150	M 16	Ø16	4
M 16 x 160	402444	M 16 x 160	M 16	Ø16	8
M 16 x 170	402445	M 16 x 170	M 16	Ø16	4
M 16 x 200	407718	M 16 x 200	M 16	Ø16	4
M 16 x 220	407719	M 16 x 220	M 16	Ø16	4
M 16 x 240	407720	M 16 x 240	M 16	Ø16	4
M 20 x 90	402446	M 20 x 90	M 20	Ø20	8
M 20 x 110	402447	M 20 x 110	M 20	Ø20	8
M 20 x 160	402448	M 20 x 160	M 20	Ø20	8
M 20 x 180	402449	M 20 x 180	M 20	Ø20	8
M 20 x 190	402450	M 20 x 190	M 20	Ø20	8
M 20 x 200	420263	M 20 x 200	M 20	Ø20	8
M 20 x 210	402451	M 20 x 210	M 20	Ø20	8
M 20 x 230	402452	M 20 x 230	M 20	Ø20	8
M 20 x 270	407721	M 20 x 270	M 20	Ø20	4
M 20 x 310	407722	M 20 x 310	M 20	Ø20	4
M 20 x 340	407723	M 20 x 340	M 20	Ø20	4

PVC-FITTINGE – CEPEX Farbe dunkelgrau ca. RAL 7024

Kappe Klebemuffe

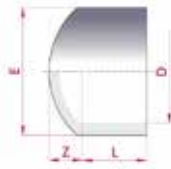

D	Art.-Nr.	DN	PN	L	Z	E	VE	
16	401942	10	16	14	7	22	20	
20	401943	15	16	16	8	25	20	
25	401944	20	16	19	9	32	20	
32	401945	25	16	22	10	40	20	
40	401946	32	16	26	12	50	10	
50	401947	40	16	31	15	63	48	
63	401948	50	16	38	17	75	24	
75	401949	65	16	44	19	90	32	
90	401950	80	16	51	23	110	16	
110	401951	100	16	61	28	131	9	
125	401952	110	16	69	32	148	15	
140	401953	125	16	76	36	163	10	
160	401954	150	10	86	40	185	6	
200	401955	175	10	106	46	224	6	☐
225	401956	200	10	119	50	252	4	☐
250	415776	225	10	131	60	282	4	☐
315	415777	300	10	164	70	357	2	☐

Stopfen IG

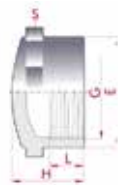

G	Art.-Nr.	DN	PN	L	E	H	S	VE	
3/8"	401957	10	10	14	24	20	24	20	
1/2"	401958	15	10	14	27	23	27	20	
3/4"	401959	20	10	16	33	28	33	20	
1"	401960	25	10	19	41	33	41	10	
1 1/4"	401961	32	10	20	50	36	50	10	
1 1/2"	401962	40	10	20	61	43	61	40	
2"	401963	50	10	24	75	50	75	22	
2 1/2"	401964	65	10	44	90	64	90	12	
3"	401965	80	10	51	108	76	108	16	
4"	401966	100	10	61	135	91	135	8	☐

Stopfen AG



G	Art.-Nr.	DN	PN	L	H	S	VE	
1/4"	402121	8	10	10	18	12	20	
3/8"	402122	10	10	10	22	20	20	
1/2"	402123	15	10	14	27	27	20	
3/4"	402124	20	10	16	30	32	20	
1"	402125	25	10	19	34	36	20	
1 1/4"	402126	32	10	21	36	46	10	
1 1/2"	402127	40	10	21	37	55	60	
2"	402128	50	10	26	42	65	70	
2 1/2"	402129	65	10	30	50	80	45	
3"	402130	80	10	33	59	93	33	
4"	402131	100	10	38	68	115	12	☐

PVC-FITTINGE – CEPEX Farbe dunkelgrau ca. RAL 7024

Übergangsmuffennippel Klebemuffe / AG



D - d x G	Art.-Nr.	DN	PN	L	LI	H	S	VE
16 - 12 x 3/8"	402073	12	10	14	11	35	24	20
20 - 16 x 1/2"	402074	15	10	16	14	42	27	20
20 - 16 x 3/8"	402075	12	10	16	11	39	27	20
25 - 20 x 3/4"	402076	20	10	19	16	47	32	20
25 - 20 x 1/2"	402077	15	10	19	14	45	32	20
25 - 20 x 3/8"	402078	12	10	19	11	42	32	20
32 - 25 x 1"	402079	25	10	22	19	54	36	20
32 - 25 x 3/4"	402080	20	10	22	16	51	36	20
32 - 25 x 1/2"	402081	15	10	22	14	49	36	20
40 - 32 x 1 1/4"	402082	32	10	26	21	60	46	10
40 - 32 x 1"	402083	25	10	26	19	58	46	10
40 - 32 x 3/4"	402084	20	10	26	16	55	46	10
50 - 40 x 1 1/2"	402085	40	10	31	25	70	55	68
50 - 40 x 1 1/4"	402086	32	10	31	21	66	55	68
50 - 40 x 1"	402087	25	10	31	19	64	55	10
63 - 50 x 2"	402088	50	10	38	25	78	65	46
63 - 50 x 1 1/2"	402089	40	10	38	21	73	65	60
63 - 50 x 1 1/4"	402090	32	10	38	21	73	65	60
75 - 63 x 2 1/2"	402091	65	10	44	30	89	78	24
75 - 63 x 2"	402092	50	10	44	25	84	78	30
75 - 63 x 1 1/2"	402093	40	10	44	21	80	78	30
90 - 75 x 3"	402094	80	10	51	33	99	93	12
90 - 75 x 2 1/2"	402095	65	10	51	30	96	93	15
90 - 75 x 2"	402096	50	10	51	25	91	93	24
110 - 90 x 4"	402097	100	10	61	40	116	120	6
110 - 90 x 3"	402098	80	10	61	33	109	120	9
110 - 90 x 2 1/2"	402099	65	10	61	30	106	120	9

Übergangsmuffe Klebemuffe / AG



D x G	Art.-Nr.	DN	PN	L	LI	E	H	VE
120 x 1/2"	402102	15	10	16	14	28	38	20
25 x 3/4"	402103	20	10	19	16	34	42	20
32 x 1"	402104	25	10	22	19	41	50	20
40 x 1 1/4"	402105	32	10	26	21	51	55	10
50 x 1 1/2"	402106	40	10	31	22	62	65	72
63 x 2"	402107	50	10	38	27	77	75	50
75 x 2 1/2"	402108	65	10	44	30	90	85	24
90 x 3"	402109	80	10	51	33	108	98	28
110 x 4"	402110	100	10	61	40	131	115	10

Doppelnippel AG / AG



D	Art.-Nr.	DN	PN	L	H	S	VE
3/8"	402111	10	10	11	32	20	20
1/2"	402112	15	10	14	40	27	20
3/4"	402113	20	10	16	44	32	20
1"	402114	25	10	19	51	36	20
1 1/4"	402115	32	10	21	55	46	10
1 1/2"	402116	40	10	21	56	55	36
2"	402117	50	10	26	66	65	46
2 1/2"	402118	65	10	30	75	90	30
3"	402119	80	10	33	81	108	12
4"	402120	100	10	38	91	135	6

PVC-FITTINGE – CEPEX Farbe dunkelgrau ca. RAL 7024

Übergangsmuffennippel Klebemuffe / IG



D - d x G	Art.-Nr.	DN	PN	L	LI	L2	H	S	VE
20 - 16 x 3/4"	402243	16	10	19	16	14	44	32	20
20 - 16 x 1/2"	402244	16	10	18	16	14	43	32	20
20 - 16 x 3/8"	402245	12	10	14	16	14	39	32	20
20 - 16 x 1/4"	402246	12	10	12	16	14	37	32	20
25 - 20 x 1"	402247	20	10	22	19	16	50	36	10
25 - 20 x 3/4"	402248	20	10	19	19	16	46	32	10
25 - 20 x 1/2"	402249	-	10	-	-	-	-	-	10
32 - 25 x 1 1/4"	402250	25	10	25	22	19	56	46	10
32 - 25 x 1"	402251	25	10	22	22	19	53	36	10
32 - 25 x 3/4"	402252	20	10	19	22	19	50	36	10
32 - 25 x 1/2"	424822	16	10	18	22	19	49	36	10
40 - 32 x 1 1/2"	402253	32	10	25	26	22	60	55	10
40 - 32 x 1 1/4"	402254	32	10	25	26	22	60	46	10
40 - 32 x 1"	402255	25	10	22	26	22	57	46	10
50 - 40 x 2"	402256	40	10	29	31	26	69	65	45
50 - 40 x 1 1/2"	402257	40	10	25	31	26	65	55	10
50 - 40 x 1 1/4"	402258	32	10	25	31	26	65	55	10
63 - 50 x 2 1/2"	402259	50	10	34	38	31	81	78	24
63 - 50 x 2"	402260	50	10	29	38	31	76	65	36
63 - 50 x 1 1/2"	402261	40	10	25	38	31	72	65	36
75 - 63 x 3"	402262	50	10	37	44	38	96	108	16
75 - 63 x 2 1/2"	402263	65	10	34	44	38	87	78	12
75 - 63 x 2"	402264	50	10	29	44	38	82	78	24
90 - 75 x 4"	402265	65	10	42	51	44	124	135	10
90 - 75 x 3"	402266	65	10	36	51	44	98	108	9
90 - 75 x 2 1/2"	402267	65	10	33	51	44	92	90	9
110 - 90 x 4"	402268	80	10	42	61	51	116	135	6
110 - 90 x 3"	402269	80	10	36	61	51	105	110	6

Druckschlauchtülle Klebestutzen

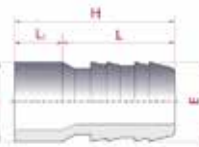

D x E	Art.-Nr.	PN	H	LI	L	E	VE
16 x 16	402200	10	49	14	35	16	20
20 x 18	402201	10	51	16	35	18	20
20 x 20	402202	10	54	16	38	20	20
25 x 25	402203	10	61	19	42	25	20
32 x 30	402204	10	69	22	47	30	20
40 x 40	402205	10	78	26	52	40	10
50 x 50	402206	10	88	31	57	50	30
50 x 38	402207	10	88	31	57	38	40
63 x 60	402208	10	98	38	60	61	18

Druckschlauchtülle AG

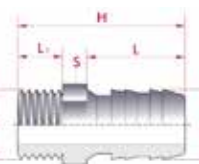

G x E	Art.-Nr.	PN	H	LI	S	L	E	VE
3/8" x 16	402217	10	54	11	35	18	16	20
1/2" x 18	402218	10	58	15	35	22	18	20
1/2" x 20	402219	10	60	15	38	22	20	20
3/4" x 25	402220	10	67	17	42	27	25	20
3/4" x 20	415763	10	62	17	36	27	20	20
1" x 30	402221	10	78	21	47	36	30	20
1" x 25	409031	10	78	21	47	36	25	20
1 1/4" x 40	402222	10	84	22	52	46	40	10
1 1/2" x 50	402223	10	89	22	57	50	50	30
1 1/2" x 38	402224	10	89	22	57	50	38	36
1 1/2" x 40	409032	10	89	22	57	50	40	36
2" x 60	402225	10	100	26	60	65	61	15

PVC-FITTINGE – CEPEX Farbe dunkelgrau ca. RAL 7024

Reduziernippel AG / IG



G x GI	Art.-Nr.	DN	PN	L	LI	H	E	S	VE
3/8" x 1/2"	402270	10	10	11	18	42	28	27	20
1/2" x 3/4"	402271	15	10	15	19	49	35	33	20
1/2" x 3/8"	402272	10	10	15	14	38	22	22	20
3/4" x 1"	402273	20	10	16	22	46	41	41	10
3/4" x 1/2"	402274	15	10	16	18	43	28	32	10
3/4" x 3/8"	402275	10	10	16	14	39	22	33	10
1" x 1 1/4"	402276	25	10	19	25	53	50	50	10
1" x 3/4"	402277	20	10	19	19	48	33	36	10
1" x 1/2"	402278	15	10	19	18	47	28	36	10
1" x 3/8"	402279	10	10	19	14	43	22	36	10
1 1/4" x 1 1/2"	402280	32	10	21	25	54	61	61	40
1 1/4" x 1"	402281	25	10	21	25	52	41	46	10
1 1/4" x 3/4"	402282	20	10	21	22	50	33	46	10
1 1/4" x 1/2"	402283	15	10	21	18	49	28	46	10
1 1/2" x 2"	402284	40	10	21	29	60	75	75	18
1 1/2" x 1 1/4"	402285	32	10	21	25	55	50	55	10
1 1/2" x 1"	402286	25	10	21	22	53	41	55	10
1 1/2" x 3/4"	402287	20	10	21	19	51	33	55	10
2" x 2 1/2"	402288	50	10	25	34	68	90	90	36
2" x 1 1/2"	402289	40	10	25	25	59	61	65	48
2" x 1 1/4"	402290	32	10	25	25	59	50	65	48
2" x 1"	402291	25	10	25	22	57	41	65	10
2 1/2" x 3"	402292	65	10	30	37	99	108	108	16
2 1/2" x 2"	402293	50	10	30	29	68	75	80	32
2 1/2" x 1 1/2"	402294	40	10	30	25	64	61	80	32
2 1/2" x 1 1/4"	402295	32	10	30	25	64	50	80	40
3" x 4"	402296	80	10	33	43	115	135	135	12
3" x 2 1/2"	402297	63	10	33	34	75	90	93	24
3" x 2"	402298	50	10	33	29	70	75	93	24
3" x 1 1/2"	402299	40	10	33	25	66	61	93	24
4" x 3"	402300	80	10	39	37	91	108	115	9
4" x 2 1/2"	402301	65	10	39	34	93	90	115	12
4" x 2"	402302	50	10	39	29	100	75	115	12

Reduziernippel AG / AG



G x GI	Art.-Nr.	DN	PN	L	LI	H	S	VE
1/2" x 3/8"	402303	10	10	15	11	36	24	20
3/4" x 1/2"	402304	15	10	16	15	43	32	20
3/4" x 3/8"	402305	10	10	16	11	39	32	20
1" x 3/4"	402306	20	10	19	16	48	40	10
1" x 1/2"	402307	15	10	19	15	47	40	10
1" x 3/8"	402308	10	10	19	11	43	40	10
1 1/4" x 1"	402309	25	10	21	19	53	50	10
1 1/4" x 3/4"	402310	20	10	21	16	50	50	10
1 1/4" x 1/2"	402311	15	10	21	15	49	50	10
1 1/2" x 1 1/4"	402312	32	10	21	21	56	55	38
1 1/2" x 1"	402313	25	10	21	19	54	55	60
1 1/2" x 3/4"	402314	20	10	21	16	51	55	60
2" x 1 1/2"	402315	40	10	25	21	61	65	24
2" x 1 1/4"	402316	32	10	25	21	61	65	33
2" x 1"	402317	25	10	25	19	58	65	33
2 1/2" x 2"	402318	50	10	30	25	70	80	30
2 1/2" x 1 1/2"	402319	40	10	30	21	66	80	45
2 1/2" x 1 1/4"	402320	32	10	30	21	66	80	45
3" x 2 1/2"	402321	65	10	33	30	78	93	24
3" x 2"	402322	50	10	33	25	73	93	24
3" x 1 1/2"	402323	40	10	33	21	69	93	36
4" x 3"	402324	80	10	38	33	86	115	12
4" x 2 1/2"	402325	65	10	38	30	83	115	12
4" x 2"	402326	50	10	38	25	78	115	12

PVC-FITTINGE – CEPEX Farbe dunkelgrau ca. RAL 7024



Einschraubteil Klebemuffe / AG

D x G	Art.-Nr.	DN	PN	L	LI	H	VE	
20 x 1"	402148	15	10	16	10	26	50	
25 x 1 1/4"	402150	20	10	19	11	29	25	
32 x 1 1/2"	402151	25	10	22	12	32	200	
40 x 2"	402153	32	10	28	15	39	60	
50 x 2 1/4"	402154	40	10	31	16	46	80	
63 x 2 3/4"	402156	50	10	38	18	56	46	
75 x 3 1/2"	402157	65	10	44	18	62	15	3
90 x 4"	402158	80	10	51	18	69	20	3
110 x 5 1/2"	402159	100	10	61	31	79	15	3

Einlegeteil Klebemuffe

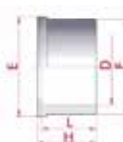

D	Art.-Nr.	DN	PN	L	E	H	F	VE	
16	420229	10	16	14	24	17	22	5	
20	402172	15	16	16	30	19	27	300	
25	402173	20	16	19	39	22	36	200	
32	402174	25	16	22	45	25	41	125	
40	402175	32	16	26	56	29	53	60	
50	402176	40	16	31	63	34	59	50	
63	402177	50	16	38	78	41	74	60	
75	402178	65	16	44	97	47	92	35	
90	402179	80	16	51	110	56	105	18	
110	402180	100	16	61	147	66	131	10	

Einlegeteil IG



G	Art.-Nr.	DN	PN	L	H	E	VE	
3/8"	420230	10	10	12	17	24	50	
1/2"	416310	15	10	15	21	30	300	
3/4"	416311	20	10	17	23	39	200	
1"	416312	25	10	20	26	45	40	
1 1/4"	416313	32	10	24	30	56	60	
1 1/2"	416314	40	10	25	35	63	50	
2"	416315	50	10	29	42	78	20	
2 1/2"	416316	65	10	34	48	97	15	
3"	416317	80	10	37	57	110	20	3
4"	416318	100	10	42	69	146	15	

Überwurfmutter IG



G	Art.-Nr.	PN	L	H	E	D	Di	VE	
3/4"	402187	10	15	20	36	22	24	300	
1"	402188	10	15	20	41	27	30	200	
1 1/4"	402189	10	16	22	52	36	39	100	
4,5	402190	10	12	18	53	33	39	200	3
1 1/2"	402191	10	20	26	60	41	45	70	
2"	402192	10	21	26	74	53	57	45	
2 1/4"	402193	10	22	30	80	59	63	35	
2"	402194	10	19	28	70	46	54	90	
2 1/2"	402195	10	18	27	90	64	72	36	
2 3/4"	402196	10	28	36	99	74	78	40	
3 1/2"	402197	10	28	36	120	92	97	30	3
4"	402198	10	28	38	133	105	110	16	3
5 1/2"	402199	10	41	56	177	131	148	15	3

PVC-FITTINGE – CEPEX Farbe dunkelgrau ca. RAL 7024

O-Ringe – EPDM für Verschraubungen PVC



G	Art.-Nr.	DN	VE
20 x 1/2"	041003	15	1
25 x 3/4"	041013	20	1
32 x 1"	041023	25	1
40 x 1 1/4"	041033	32	1
50 x 1 1/2"	041043	40	1
63 x 2"	041053	50	1
75 x 2 1/2"	041063	65	1
90 x 3"	041073	80	1
110 x 4"	041083	90	1

Anbohrschellen mit Verstärkungsring

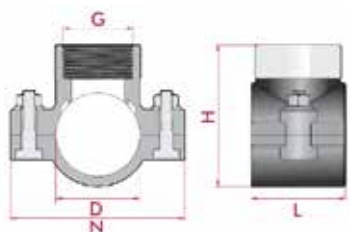

Größe	Art.-Nr.	PN	N	L	H	Schrauben	VE
25 x 1/2"	411435	10	67	24	52,5	2	100
25 x 3/4"	402379	10	67	24	52,5	2	100
32 x 1/2"	411436	10	79	31	61,5	2	60
32 x 3/4"	411437	10	79	31	61,5	2	60
32 x 1"	402380	10	79	31	67,5	2	30
40 x 1/2"	411438	10	85	50	74,5	2	40
40 x 3/4"	411439	10	85	50	74,5	2	40
40 x 1"	402381	10	85	50	74,5	2	40
50 x 1/2"	411440	10	103	52	84,5	2	70
50 x 3/4"	411441	10	103	52	84,5	2	70
50 x 1"	402382	10	103	52	84,5	2	70
50 x 1 1/4"	428678	10	103	52	84,5	2	70
63 x 1/2"	428679	10	101	70	103,5	4	50
63 x 3/4"	411442	10	101	70	103,5	4	50
63 x 1"	402383	10	101	70	103,5	4	50
63 x 1 1/4"	428680	10	101	70	103,5	4	40
63 x 1 1/2"	411443	10	101	70	103,5	4	40
75 x 1/2"	411444	10	114	75	113	4	50
75 x 3/4"	411445	10	114	75	113	4	50
75 x 1"	402384	10	114	75	113	4	50
75 x 1 1/4"	428681	10	114	75	113	4	50
75 x 1 1/2"	411446	10	114	75	113	4	50
90 x 1/2"	411447	10	125	84,5	129	4	40
90 x 3/4"	411448	10	125	84,5	129	4	40
90 x 1"	402385	10	125	84,5	129	4	40
90 x 1 1/4"	411449	10	125	84,5	129	4	40
90 x 1 1/2"	411450	10	125	84,5	129	4	40
90 x 2"	436878	10					40
110 x 1"	402386	10	150	99	151	4	40
110 x 1 1/2"	411451	10	150	99	151	4	40
110 x 2"	411452	10	150	99	151	4	40
125 x 1"	411453	10	171	99,5	167	4	35
125 x 1 1/2"	411454	10	171	99,5	167	4	35
125 x 2"	411455	10	171	99,5	167	4	35
140 x 1"	406022	10	180	137	188,5	6	25
140 x 1 1/2"	406024	10	180	137	188,5	6	25
140 x 2"	406025	10	180	137	188,5	6	25
140 x 3"	406026	10	180	137	188,5	6	20
160 x 1"	406027	10	208	137	213	6	20
160 x 1 1/2"	406029	10	208	137	213	6	20
160 x 2"	406030	10	208	137	213	6	20
160 x 3"	406031	10	208	137	213	6	15

FLEXIBLE FITTINGE

Die ideale Lösung für Anwendungen, bei denen Kleben nicht möglich oder nicht erwünscht ist. Geeignet für den mehrfachen Gebrauch. Auch wenn die Rohrverbindung nicht rechtwinkelig oder gerade ist, passen sich diese Fittings an. Material: PVC Elastomer. PVC Elastomer hat eine sehr starke Zug- und Reißfestigkeit, ist enorm flexibel und nicht der Alterung unterworfen („verkauscheln“).

Außenrohr	Außenrohr	Außen Druckfitting	Klemmbereich
1 1/4"	40 mm	32	41-38 mm
1 1/2"	50 mm	40	50-44 mm
2"	63 mm	50	63-57 mm
3"	90 mm	75	90-82 mm
4"	110 mm	90	110-100 mm

D 50 mm Rohr
50 mm Fitting
Außenmaß = 60,5 mm



Achtung: max. 1 bar Druck!



FLEXIBLE MUFFE

Art. Nr.	Masse	Klemmbereich	VE
SBFC119	1 1/4" / 40mm	41-38 mm	100
SBFC120	1 1/2" / 50mm	50-44 mm	100
SBFC122	2" / 63mm	63-57 mm	100
SBFC126	3" / 90mm	90-82 mm	80
SBFC128	4" / 110mm	110-100 mm	60



FLEXIBLE REDUZIERMUFFE

Art. Nr.	Masse	VE
SBFC140	1 1/2" x 1 1/4" / 50 x 40mm	100
SBFC142	2" x 1 1/2" / 63 x 50mm	100
SBFC146	3" x 2" / 90 x 63mm	80
SBFC147	4" x 2" / 110 x 63mm	60
SBFC148	4" x 3" / 110 x 90mm	60



FLEXIBLES T-STÜCK

Art. Nr.	Masse	Klemmbereich	VE
SBFC150	1 1/2" / 50mm	50-44 mm	50
SBFC152	2" / 63mm	63-57 mm	20
SBFC156	3" / 90mm	90-82 mm	20
SBFC158	4" / 110mm	110-100 mm	6



FLEXIBLE ENDKAPPE

Art. Nr.	Masse	Klemmbereich	VE
SBFC160	1 1/2" / 50mm	50-44 mm	160
SBFC162	2" / 63mm	63-57 mm	150
SBFC166	3" / 90mm	90-82 mm	100
SBFC168	4" / 110mm	110-100 mm	80



FLEXIBLER BOGEN

Art. Nr.	Masse	Klemmbereich	VE
SBFC170	1 1/2" / 50mm	50-44 mm	50
SBFC172	2" / 63mm	63-57 mm	20
SBFC176	3" / 90mm	90-82 mm	20
SBFC178	4" / 110mm	110-100 mm	6

KUGELHAHN – PRAHER



S6 – SAFETY STANDARD

Material: PVC / PN 10, Kugelsitzring: PE, Dichtung: EPDM

Art. Nr.	DN		PN	DA	
08135	40	S6	16	50	
08136	50	S6	16	63	



PVC LABORKUGELHAHN PR

Material: PVC/INDUSTRIE DN6 / PN10
O-Ringe: EPDM, O-Ringe: FPM VITON

Art. Nr.	Bezeichnung	Gewinde	
08180	Laborkugelhahn PVC-EPDM	1/4" 1G x 1/4" AG	

(Mit Set = Tülle, Doppelnippel und Stopfen 1/4" x NW 6/10)



PVC-ABLASSVENTILE PN 10 PRAHER – CEPEX

Material: PVC, max. Betriebsdruck: PN 10

Art. Nr.	Bezeichnung	Gewinde	
080671	Ablassventil schwarz	3/4" AG x 3/4" AG	
080681	Ablassventil schwarz	3/4" AG x NW 16 (Gardenaanschluss)	
04116	Ablassventil	3/4" 1G / 3/4" AG	
04118	Üw-Mutter und Tülle	3/4" 1G x NW 19	
04468	Ablassventil	1/4" AG x NW 10	

PVC-FITTINGE – PN 16 – IBG Farbe dunkelgrau ca. RAL 7011



Winkel 90° Klebemuffe

Art. Nr.	DN	VE	DA
503106	40	40	50
503116	50	70	63



Winkel 45°

Art. Nr.	DN	VE	DA
650330	40	5	50
650340	50	2	63



T-Stücke egal 90°

Art. Nr.	DN	VE	DA
509106	40	30	50
509110	50	30	63



Muffen

Art. Nr.	DN	VE	DA
501050	40	60	50
501060	50	50	63



Behälterverschraubungen

G1	G2	Art.-Nr.	VE	D1 x G1
3/8"	3/4"	608000 x	10	16 x 3/8"
1/2"	1"	608010 x	10	20 x 1/2"
3/4"	1"	608020 x	10	20 x 3/4"
1"	1 1/4"	608030 x	10	25 x 1"
1 1/2"	2"	608040 x	10	40 x 1 1/2"
2"	2 3/4"	608050 x	10	63 x 2"



G1	G2	Art.-Nr.	VE	D1 x D2
50	63	533478 x	45	50 x 2"
50	63	533420 x	45	50 x 2 1/4"
63	75	533430 x	25	63 x 2 1/2"
75	90	533440 x	24	75 x 3"
90	110	533450 x	10	90 x M 113



Bitte beachten: x = PN10

PVC-FITTINGE – PN 16 – IBG Farbe dunkelgrau ca. RAL 7011 / ROTGUSS / EDELSTAHL



Verschraubungen Klebemuffe x Klebemuffe mit O-Ring EPDM

Art. Nr.	DN	VE	DA
500160	40	32	50
500170	50	20	63



Verschraubungen Klebemuffe x IG mit O-Ring EPDM

Art. Nr.	DN	VE	DA x IG
654830x	40	2	50 x 1 1/2"
654840x	50	2	63 x 2"



Übergangverschraubungen Klebemuffe x AG mit O-Ring

Art. Nr.	DN	VE	DA x AG
500260x	40	40	50 x 1 1/2"
500400	40	10	50 x 2"
500270x	50	35	63 x 2"



Übergangverschraubungen Rotguss Klebemuffe x IG

Art. Nr.	DN	VE	DA x IG
600310	15	10	15 x 1/2"
600320	20	10	20 x 3/4"
600330	25	10	25 x 1"
600340	32	10	32 x 1 1/4"
600350	40	10	40 x 1 1/2"
600360	50	10	50 x 2"



Übergangverschraubungen – Rotguss Klebemuffe x AG

Art. Nr.	DN	VE	DA x AG
600410	15	10	20 x 1/2"
600420	20	10	25 x 3/4"
600430	25	10	32 x 1"
600440	32	10	40 x 1 1/4"
600450	40	10	50 x 1 1/2"
600460	50	10	63 x 2"
600455 V4A	40	10	50 x 1 1/2"
13751 V2A	40	10	50 x 1 1/2"



i Bitte beachten: x = PN10

ROHRKLEMMEN – PRAHER

**Rohrklemme Typ Praher
aus Polypropylen (VE = 20 Stück verpackt)**

Dim.	NW	Art.-Nr.	VE	DA	
16-19 mm	10	08000	20	16	
20-23 mm	16	08001	20	20	
25-28 mm	20	08002	20	25	
31-35 mm	25	08003	20	32	
39-43 mm	32	08004	20	40	
47-51 mm	40	08005	500	50	
60-65 mm	50	08006	300	63	
72-80 mm	63	08007	10	75	
87-95 mm	75	08008	10	90	

ROHRKLEMMEN PP – CEPEX



Typ	Art.-Nr.	DN	DA	VE	
A	402132	16	20	150	
A	402133	20	25	110	
A	402134	25	32	90	
A	402135	32	40	100	
B	402140	40	50	110	
B	402141	50	63	70	
B	402142	63	75	90	
B	402143	75	90	54	
B	408916	90	110	20	
B	408917	100	125	18	
B	410956	110	140	13	
B	408918	140	160	10	
B	410958	200	225	6	

MAUERKRAGEN FÜR ROHRDURCHFÜHRUNG EPDM

Abdichtungswirkung bis 60 m WS, Mauerkragen-Montageset beinhaltet 1 Mauerkragen und 2 Edelstahl-Spannbänder (auf die Dimension abgestimmt)



Rohr-D Aussen	D-Bereich Aussen	Art.-Nr.	DI (mm)	LI (m)	
DA 32	32-36	16102	29	0,45	
DA 40	40-44	16103	38	0,5	
DA 50	50-55	16104	48	0,6	
DA 63	63-69	16105	60	0,7	
DA 75	75-82	16106	71	0,8	
DA 90	90-97	16107	84	0,9	
DA 110	110-121	16108	105	1,0	
DA 125	125-140	16109	120	1,1	
DA 140	125-140	16110	120	1,2	
DA 160	160-170	16111	154	1,3	
DA 225	225-240	16114	215	2,1	
DA 280	280-290	16116	275	2,5	
DA 315	315-330	16117	310	2,6	

PVC-DRUCKROHRE PN 10 / grau gemufft – Stangenware



i Achtung: Die Auslieferung von PN10 PVC-Druckrohren grau erfolgt nur in ganzen Stangen!

Rohr gemufft

Rohrlänge:	DN	Art.-Nr.	VE	DA
5 lfm	20	402706	1	25
5 lfm	25	402707	1	32
5 lfm	32	402708	1	40
5 lfm	40	402709	1	50
2 lfm	40	4027092	1	50
3 lfm	40	4027093	1	50
5 lfm	50	402710	1	63
3 lfm	50	4027103	1	63
5 lfm	65	402711	1	75
5 lfm	80	402712	1	90
5 lfm	100	402713	1	110
5 lfm	125	402715	1	140
5 lfm	150	402716	1	160
5 lfm	200	402717	1	225
5 lfm	250	402718	1	280
5 lfm	300	402719	1	315

PVC-DRUCKROHRE PN 16 / grau gemufft – Stangenware



i Achtung: Die Auslieferung von PN16 PVC-Druckrohren grau erfolgt nur in ganzen Stangen!

Rohr gemufft

Rohrlänge:	DN	Art.-Nr.	VE	DA
5 lfm	10	402721	1	16
5 lfm	15	402722	1	20
5 lfm	20	402723	1	25
5 lfm	25	402724	1	32
5 lfm	32	402725	1	40
5 lfm	40	402726	1	50
3 lfm	40	4027263	1	50
5 lfm	50	402727	1	63
3 lfm	50	4027273	1	63
5 lfm	65	402728	1	75
5 lfm	80	402729	1	90
5 lfm	100	402730	1	110
5 lfm	125	402731	1	140
5 lfm	150	402732	1	160
5 lfm	200	402733	1	225

PVC-DRUCKROHRE PN 10 / transparent ungemufft – Meterware



i Achtung: Die Auslieferung von PN10 PVC-Druckrohren transparent erfolgt nur in ganzen Stangen!

Rohr ungemufft

Rohrlänge:	DN	Art.-Nr.	VE	DA
1 lfm	40	16305	1	50
1 lfm	50	16306	1	63
1 lfm	65	16307	1	75
1 lfm	80	16308	1	90
1 lfm	100	16309	1	110
1 lfm	125	16310	1	140
1 lfm	150	16311	1	160

PVC-DRUCKROHRE PN 16 / schwarz gemufft – Stangenware

i Achtung: Die Auslieferung von PN16 PVC-Druckrohren schwarz erfolgt nur in ganzen Stangen!

Rohr gemufft

Rohrlänge:	DN	Art.-Nr.	VE	DA
5 lfm	40	402705	1	50

ROHRKLEMMEN – PRAHER



i in Rollen zu 25 m Farbe grau
Kälte- aber nicht frostbeständig

Bezeichnung	Art.-Nr.	DA	Rolle	D	d
Flexschlauch	183211	20	25 m	20	16
Flexschlauch	183221	25	25 m	25	20
Flexschlauch	183231	32	25 m	32	26
Flexschlauch	183241	40	25 m	40	34
Flexschlauch	183275	50	12 m	50	43
Flexschlauch	183251	50	25 m	50	43
Flexschlauch	183277	50	25 m	50	40 verstärkte Ausf.
Flexschlauch	183261	63	25 m	63	55
Flexschlauch	183271	75	25 m	75	65
Flexschlauch	183273	90	25 m	90	80

40599247 Muffe extra lang DA 50, speziell für Klebeschlauch

40599248 Muffe extra lang DA 63, speziell für Klebeschlauch

Vorteile bei der Verwendung von weich PVC-Schlauch gegenüber PVC- und Rohr:

- einfach zu transportieren
- weniger Fittinge und Klebestellen, da sich der Schlauch der Form anpasst
- kürzere Montagezeiten
- bis zu 25 m ohne Verbindungsfittinge möglich
- Wandstärke 4 mm

i **Achtung:** Der Klebeschlauch muss in einem Sandbett verlegt werden, bei unzugänglichen Stellen (z.B. unter gefliesten Betonteilen) empfehlen wir dringend die Verlegung im Doppelrohr! Eine protokollierte Druckprüfung ist vor dem Hinterfüllen und vor der Inbetriebnahme zwingend erforderlich! (EN-Norm)

POOL-PVC-FLEXKLEBESCHLAUCH – **fit b-active flex**

i **Achtung:** Der Klebeschlauch muss in einem Sandbett verlegt werden! Eine protokollierte Druckprüfung ist vor dem Hinterfüllen und vor der Inbetriebnahme zwingend erforderlich! (EN-Norm) Der Klebeschlauch ist nicht als Leitung zur Wassernachspeisung geeignet!

Bezeichnung	Art.-Nr.	DA	Rolle	D	
Flexschlauch	183285	50	25 m	50	Gruppe B
Flexschlauch	183286	63	25 m	63	Gruppe B



BONDITE-Kleber PVC-U mit Pinsel

Gewicht kg		Art.-Nr.	VE
0,25 kg	Dosen	427050	30 Stk.
1,00 kg	Dosen	427052	12 Stk.

GRIFFON-Kleber WDF-05



Liter		Art.-Nr.	VE
0,25 l mit Pinsel-Verschluss	Dosen WDF5	538780	12 Stk.
0,5 l	Dosen WDF5	538781	12 Stk.

POOL-PVC-FLEXKLEBESCHLAUCH – **fit b-active flex**

550550	PVC-U-Übergangverschraubung, d 50 Klemm x DA 50 Klebestutze	VE = 30
550650	PVC-U-Übergangverschraubung, d 50 Klemm x DA 50 Klebemuffe	VE = 24
551250	PVC-U-Übergangverschraubung, d 50 Klemm x 1 1/2" IG	VE = 24
550750	PVC-U-Übergangverschraubung, d 50 Klemm x 1 1/2" AG + O-Ring	VE = 25
550700	PVC-U-Übergangverschraubung, d 50 Klemm x 2" AG + O-Ring	VE = 24
551050	PVC-U-Doppelverschraubung, d 50 Klemm x d 50 Klemm	VE = 16

i Der Klebeschlauch ist nicht als Leitung zur Wassernachspeisung geeignet!

FLEX-FIT die Klemmverbindung für den PVC-Schlauch DA 50

	550960	PVC-U-Übergangswinkel 45°, DA 50 Klebemuffe x d 50 Klemm	VE = 25
	550850	PVC-U-Übergangswinkel 90°, DA 50 Klebemuffe x d 50 Klemm	VE = 25
	550900	PVC-U-Übergangswinkel 90°, D 50 Klemm x 1 1/2" AG	VE = 25
	550950	PVC-U-Übergangswinkel 90°, d 50 Klemm x d 50 Klemm	VE = 10
	550855	PVC-U-Übergangswinkel 90°, DA 50 Klebemuffe x 1 1/2" IG	VE = 25
	550350	PVC-U-Übergangs T-Stück 90°, DA 50 Klebemuffe x d 50 Klemm x DA 50 Klebemuffe	VE = 18
	550450	PVC-U-Übergangs T-Stück 90°, d 50 Klemm x d 50 Klemm x d 50 Klemm	VE = 8
	550460	PVC-U-Übergangs T-Stück 90°, d 50 Klemm x DA 63 x d 50 Klemm	VE = 6
	550470	PVC-U-Übergangs T-Stück 90°, 50 Klemm x d 63 Klemm x d 50 Klemm	VE = 8

FLEX-FIT die Klemmverbindung für den PVC-Schlauch DA 63

	563550	PVC-U-Übergangsverschraubung, d 63 Klemm x DA 63 Klebestutzen	VE = 25
	563650	PVC-U-Übergangsverschraubung, d 63 Klemm x DA 63 Klebemuffe	VE = 25
	563655	PVC-U-Doppelverschraubung, d 63 Klemm x d 63 Klemm	VE = 18
	563750	PVC-U-Verschraubung, d 63 Klemm x 2" AG + O-Ring	VE = 36
	563755	PVC-U-Verschraubung, d 63 Klemm x 2" IG	VE = 25
	563850	PVC-U-Übergangswinkel 90°, d 63 Klemm x DA 63 Klebemuffe	VE = 25
	563950	PVC-U-Winkel 90°, d 63 Klemm x d 63 Klemm	VE = 10
	563855	PVC-U-Übergangswinkel 90°, d 63 Klemm x 2" IG	VE = 24
	563350	PVC-U-Übergangs-T-Stück, DA 63 Klebemuffe x d 63 Klemm	VE = 16
	563450	PVC-U-T-Stück 90°, d 63 Klemm x d 63 Klemm x d 63 Klemm	VE = 10
	550120	Montageschlüssel Flex-Fit, DA 50	VE = 10
	563120	Montageschlüssel Flex-Fit, DA 63	VE = 10

i Der Klebeschlauch ist nicht als Leitung zur Wassernachspeisung geeignet!

PVC-KLEBER-REINIGER / TANGIT / SABA / GRIFFON



GRIFFON-Kleber UNI 100

Liter		Art.-Nr.	VE
0,25 l mit Pinsel-Schnell-Verschluß	Dosen	538750A	24 Stk.
0,50 l mit Pinsel-Schnell-Verschluß	Dosen	538760A	12 Stk.
1,00 l mit Pinsel-Schnell-Verschluß	Dosen	538770A	8 Stk.

i **Achtung: nur zum Kleben von PVC.**

0,25 l mit Pinsel-Schnell-Verschluß	Dosen WDF5	538780	12 Stk.
0,50 l	Dosen WDF5	538781	12 Stk.

i **Besonders für Klebeschläuche geeignet. Auch bei Feuchtigkeit verklebbar!**



PVC-REINIGER TANGIT / GRIFFON

Liter		Art.-Nr.	VE
0,125 l	Tangit	16224	20 Stk.
0,50 l	Griffon	538670	12 Stk.
1,00 l	Tangit	16225	12 Stk.
0,125 l	Cepex	402433	28 Stk.
0,50 l	Cepex	402432	15 Stk.
1,00 l	Cepex	402431	12 Stk.

TEFLONDICHTBAND



Rolle	Art.-Nr.	VE
spezial	538900	10 Stk.



538795 Kolmat Dichtband

- für alle Gewindeverbindungen geeignet
- Metall, Kunststoff oder in Kombination miteinander
- geeignet für Wasser, Dampf, Gas, Druckluft, etc.
- belastbar bis 160° C und 26 bar
- leicht und schnell anzubringen
- saubere Verarbeitung
- füllt Spaltmaße und Toleranzen perfekt aus
- passt sich allen Gewindeformen an
- zurückdrehen >180°
- direkt belastbar und demontierbar
- eine perfekte Verbindung, 100 % dicht

! **Bitte beachten Sie**, dass aufgrund des nationalen Gefahrgutbeförderungsgesetzes (GGBG) und den internationalen Gefahrgutvorschriften für den Strassentransport (ADR) die Lieferung von Chlor- und allen anderen Gefahrgütern (z.B.: Schwimmbadchemikalien, Kleber etc.) nur noch in Verpackungseinheiten erfolgen kann. Die Rücknahme von Chlor- und allen anderen Gefahrgütern (z.B.: Schwimmbadchemikalien, Kleber etc.) ist. Aufgrund der oben genannten gesetzlichen Regelungen nur in geschlossenen Originalverpackungen möglich.
Die Rücknahme von bereits geöffneten Verpackungen und/oder Einzelgebänden ist ausnahmslos nicht möglich!

GRIFFON ZUBEHÖR



538801 Kabelsäge

ABDICHTUNG UND REPARATUR

NEU



537685 Dichtband für Leckagen
 VE 6, 25 mm x 3 m
 Selbstverschweißendes Reparaturband zur temporären Abdichtung von Lecks an Rohrleitungen und Bewässerungsrohren oder als Schutz vor scharfkantigen und hervorstehenden Teilen. Schmilzt bei Anbringung unter Spannung schnell zu einer homogenen Masse.



537690 Dichtbandage für Hart-PVC-Rohre
 VE 6, 1,5 m x 5 cm
 Band zur dauerhaften Reparatur von Löchern und Rissen an zylinderförmigen Materialien aller Art an feuchten Oberflächen und selbst unter Wasser. Rohrdurchmesser unter Druck bis 2" (50 x 60) oder 50 mm. Bei über 20 bar zweites Band vorsehen. Bei Abfluss und Fallrohren auch für sehr große Rohrdurchmesser geeignet.



537695 Leck-Fix
 VE 6, 1 lit. Kansiter
 Für kleine Undichtigkeiten in Schwimmbädern unterschiedlichster Bauart (Beton, Polyester, Acryl, Abdichtungsplane), sowie an in der Erde verlegten Rohrleitungen. Behandlung von Leckagen von 0,5 m³ bis 0,8 m³ pro Tag bei Becken zwischen 50 m³ und 60 m³ (entspricht Absinken des Wasserspiegels um ca. 2 cm bei einem Becken von 10 m x 5 m). Größere Schäden erfordern weitergehende Maßnahmen.



537700 Universal-Flachabdichtung
 VE 6, 2 m, Blister 6er Set
 Für Rohrleitungen, Flansche, Wärmetauscher, Gehäuseabdichtung von Pumpen, Boiler, Mann-Löcher, Lüftungs- und Klima-Anlagen.



537675 Dichtungskitt
 VE 18, Dose 500 g
 Chlor und Salzwasser beständige Dichtungsmasse zum Eindichten von Skimmern oder Bodenabläufen. Verhindert Entstehung von Schwitzwasser und Kontaktkorrosion zum Beispiel in der Kabelanschlussdose.



537680 Skimmer-Reparatur
 VE 12, Dose 125 ml
 Zur Reparatur von Rissen in Skimmern, Bodenabläufen oder anderen ABS-Teilen.